

Welding machine

Picomig 305 Synergic TKM

099-005698-EW501

Observe additional system documents!

09.10.2024

**Register now
and benefit!**
**Jetzt Registrieren
und Profitieren!**

www.ewm-group.com



General instructions

WARNING



Read the operating instructions!

The operating instructions provide an introduction to the safe use of the products.

- Read and observe the operating instructions for all system components, especially the safety instructions and warning notices!
- Observe the accident prevention regulations and any regional regulations!
- The operating instructions must be kept at the location where the machine is operated.
- Safety and warning labels on the machine indicate any possible risks. Keep these labels clean and legible at all times.
- The machine has been constructed to state-of-the-art standards in line with any applicable regulations and industrial standards. Only trained personnel may operate, service and repair the machine.
- Technical changes due to further development in machine technology may lead to a differing welding behaviour.

In the event of queries on installation, commissioning, operation or special conditions at the installation site, or on usage, please contact your sales partner or our customer service department on +49 2680 181-0.

A list of authorised sales partners can be found at www.ewm-group.com/en/specialist-dealers.

Liability relating to the operation of this equipment is restricted solely to the function of the equipment. No other form of liability, regardless of type, shall be accepted. This exclusion of liability shall be deemed accepted by the user on commissioning the equipment.

The manufacturer is unable to monitor whether or not these instructions or the conditions and methods are observed during installation, operation, usage and maintenance of the equipment.

An incorrectly performed installation can result in material damage and injure persons as a result. For this reason, we do not accept any responsibility or liability for losses, damages or costs arising from incorrect installation, improper operation or incorrect usage and maintenance or any actions connected to this in any way.

© EWM GmbH

Dr. Günter-Henle-Strasse 8

56271 Mündersbach Germany

Tel.: +49 2680 181-0, Fax: -244

Email: info@ewm-group.com

www.ewm-group.com

The copyright to this document remains the property of the manufacturer.

Copying, including extracts, only permitted with written approval.

The content of this document has been prepared and reviewed with all reasonable care. The information provided is subject to change; errors excepted.

Data security

The user is responsible for backing up data of all changes from the factory setting. The user is liable for erased personal settings. The manufacturer does not assume any liability for this.

1 Contents

1	Contents	3
2	For your safety	7
2.1	Notes on using these operating instructions.....	7
2.2	Explanation of icons.....	8
2.3	Safety instructions.....	9
2.4	Transport and installation	12
3	Intended use	14
3.1	Applications.....	14
3.2	Software version	14
3.3	Documents which also apply	14
3.3.1	Warranty	14
3.3.2	Declaration of Conformity.....	14
3.3.3	Welding in environments with increased electrical hazards.....	14
3.3.4	Service documents (spare parts and circuit diagrams).....	14
3.3.5	Calibration/Validation	14
3.3.6	Part of the complete documentation.....	15
4	Machine description – quick overview	16
4.1	Front view / rear view.....	16
4.2	Inside view	18
4.3	Machine control – Operating elements	20
4.3.1	Welding data display	22
4.3.1.1	Polarity setting.....	22
5	Design and function	23
5.1	Transport and installation	23
5.1.1	Ambient conditions	23
5.1.2	Machine cooling.....	24
5.1.3	Workpiece lead, general.....	24
5.1.4	Welding torch cooling system.....	24
5.1.4.1	Cooling unit connection.....	24
5.1.5	Notes on the installation of welding current leads	25
5.1.6	Stray welding currents	26
5.1.7	Mains connection.....	27
5.1.7.1	Mains configuration	27
5.1.8	Welding torch holder	28
5.1.9	Shielding gas supply (shielding gas cylinder for welding machine)	29
5.1.9.1	Pressure regulator connection	29
5.1.9.2	Shielding gas hose connection	30
5.1.9.3	Shielding gas volume settings	30
5.1.9.4	Gas test.....	31
5.2	MIG/MAG welding.....	31
5.2.1	Welding torch and workpiece line connection	31
5.2.2	MIG/MAG function torch.....	33
5.2.3	MIG/MAG Push/Pull welding torch	33
5.2.4	Wire feed	33
5.2.4.1	Inserting the wire spool	34
5.2.4.2	Changing the wire feed rollers	35
5.2.4.3	Inching the wire electrode	37
5.2.4.4	Spool brake setting	38
5.2.5	Definition of MIG/MAG welding tasks.....	38
5.2.6	Welding task selection.....	39
5.2.6.1	Basic welding parameters.....	39
5.2.6.2	Operating mode	39
5.2.7	Welding power (operating point)	40
5.2.7.1	Selecting the welding parameter display mode	40
5.2.7.2	Arc length.....	40
5.2.7.3	Arc dynamics (choke effect).....	40
5.2.8	Conventional MIG/MAG Welding (GMAW non synergic).....	40
5.2.9	forceArc	41

5.2.10	rootArc	42
5.2.11	Operating modes (functional sequences).....	42
	5.2.11.1 Explanation of signs and functions.....	42
	5.2.11.2 Automatic cut-out	42
5.2.12	Program sequence	49
5.2.13	Expert menu (MIG/MAG).....	50
5.3	MMA welding.....	51
5.3.1	Connecting the electrode holder and workpiece lead	51
5.3.2	Welding task selection	51
5.3.3	Arcforce.....	52
5.3.4	Hotstart	52
5.3.5	Antistick.....	52
5.3.6	Expert menu (MMA).....	53
5.4	TIG welding	53
5.4.1	Preparing the TIG welding torch.....	53
5.4.2	Welding torch and workpiece line connection	53
5.4.3	Welding task selection	54
5.4.4	Adjusting the gas post-flow time.....	54
5.4.5	Expert menu (TIG).....	55
5.4.6	Arc ignition	56
	5.4.6.1 Liftarc.....	56
5.4.7	Operating modes (functional sequences).....	56
	5.4.7.1 Explanation of symbols	56
	5.4.7.2 Automatic cut-out	56
	5.4.7.3 Non-latched mode	57
	5.4.7.4 Latched mode.....	58
5.5	Remote control.....	58
5.6	Special parameters (advanced settings).....	58
5.6.1	Selecting, changing and saving parameters.....	59
5.6.2	Special parameters in detail	60
	5.6.2.1 Ramp time for wire inching (P1).....	60
	5.6.2.2 Latched/special-latched tap start (P9).....	60
5.6.3	Reset to factory settings	60
5.7	Machine configuration menu	61
5.7.1	Selecting, changing and saving parameters.....	61
5.7.2	Aligning the cable resistance	62
5.7.3	Power-saving mode (Standby)	63
6	Maintenance, care and disposal	64
6.1	General.....	64
6.2	Explanation of icons	64
6.3	Maintenance schedule	65
6.4	Disposing of equipment.....	66
7	Rectifying faults.....	67
7.1	Checklist for rectifying faults	67
7.2	Error messages (power source).....	68
7.3	Software version of the machine control.....	69
7.4	Resetting welding parameters to the factory settings	70
7.5	Resetting JOBS (welding tasks) to the factory settings.....	71
	7.5.1 Resetting a single JOB	71
	7.5.2 Resetting all JOBS	71
7.6	Welding parameter calibration	72
7.7	Vent coolant circuit.....	73
8	Technical data.....	74
8.1	Picomig 305 Synergic TKM.....	74
9	Accessories	75
9.1	Welding torch cooling system	75
9.2	Transport system	75
9.3	Remote control/connecting and extension cable	75
	9.3.1 19-pole connection	75

9.4	Option for retrofitting	75
9.5	Shielding gas supply (shielding gas cylinder for welding machine).....	76
9.6	General accessories	76
10	Replaceable parts	77
10.1	Wire feed rollers.....	77
10.1.1	Wire feed rollers for steel wire	77
10.1.2	Wire feed rollers for aluminium wire	77
10.1.3	Wire feed rollers for cored wire	78
10.1.4	Wire guide	78
11	Appendix.....	79
11.1	JOB-List	79
11.2	Parameter overview – setting ranges	80
11.3	Average wire electrode usage	80
11.4	Average shielding gas usage.....	81
11.4.1	MIG/MAG welding	81
11.4.2	TIG welding	81
11.5	Searching for a dealer	82

2 For your safety

2.1 Notes on using these operating instructions

DANGER

Working or operating procedures which must be closely observed to prevent imminent serious and even fatal injuries.

- Safety notes include the "DANGER" keyword in the heading with a general warning symbol.
- The hazard is also highlighted using a symbol on the edge of the page.

WARNING

Working or operating procedures which must be closely observed to prevent serious and even fatal injuries.

- Safety notes include the "WARNING" keyword in the heading with a general warning symbol.
- The hazard is also highlighted using a symbol in the page margin.

CAUTION

Working or operating procedures which must be closely observed to prevent possible minor personal injury.

- The safety information includes the "CAUTION" keyword in its heading with a general warning symbol.
- The risk is explained using a symbol on the edge of the page.



Technical aspects which the user must observe to avoid material or equipment damage.

Instructions and lists detailing step-by-step actions for given situations can be recognised via bullet points, e.g.:

- Insert the welding current lead socket into the relevant socket and lock.

2.2 Explanation of icons

Symbol	Description	Symbol	Description
	Indicates technical aspects which the user must observe.		Activate and release / Tap / Tip
	Switch off machine		Release
	Switch on machine		Press and hold
	Incorrect / Invalid		Switch
	Correct / Valid		Turn
	Input		Numerical value – adjustable
	Navigation		Signal light lights up in green
	Exit		Signal light flashes green
	Time representation (e.g.: wait 4 s / actuate)		Signal light lights up in red
	Interruption in the menu display (other setting options possible)		Signal light flashes red
	Tool not required/do not use		Signal light lights up in blue
	Tool required/use		Signal light flashes blue

2.3 Safety instructions

WARNING



Risk of accidents due to non-compliance with the safety instructions!
Non-compliance with the safety instructions can be fatal!

- Carefully read the safety instructions in this manual!
- Observe the accident prevention regulations and any regional regulations!
- Inform persons in the working area that they must comply with the regulations!



Risk of injury from electrical voltage!

Voltages can cause potentially fatal electric shocks and burns on contact. Even low voltages can cause a shock and lead to accidents.

- Never touch live components such as welding current sockets or stick, tungsten or wire electrodes!
- Always place torches and electrode holders on an insulated surface!
- Wear the full personal protective equipment (depending on the application)!
- The machine may only be opened by qualified personnel!
- The device must not be used to defrost pipes!



Hazard when interconnecting multiple power sources!

If a number of power sources are to be connected in parallel or in series, only a technical specialist may interconnect the sources as per standard IEC 60974-9:2010: Installation and use and German Accident Prevention Regulation BVG D1 (formerly VBG 15) or country-specific regulations.

Before commencing arc welding, a test must verify that the equipment cannot exceed the maximum permitted open circuit voltage.

- Only qualified personnel may connect the machine.
- When taking individual power sources out of operation, all mains and welding current leads must be safely disconnected from the welding system as a whole. (Hazard due to reverse polarity voltage!)
- Do not interconnect welding machines with pole reversing switch (PWS series) or machines for AC welding since a minor error in operation can cause the welding voltages to be combined, which is not permitted.



Risk of injury due to radiation or heat!

Arc radiation can lead to skin and eye injuries.

Contact with hot workpieces and sparks can lead to burns.

- Use hand shield or welding helmet with the appropriate safety level (depends on the application).
- Wear dry protective clothing (e.g. hand shield, gloves, etc.) in accordance with the applicable regulations of your country.
- Persons who are not directly involved should be protected with a welding curtain or suitable safety screen against radiation and the risk of blinding!

WARNING



Risk of injury due to improper clothing!

During arc welding, radiation, heat and voltage are sources of risk that cannot be avoided. The user has to be equipped with the complete personal protective equipment at all times. The protective equipment has to include:

- Respiratory protection against hazardous substances and mixtures (fumes and vapours); otherwise implement suitable measures such as extraction facilities.
- Welding helmet with proper protection against ionizing radiation (IR and UV radiation) and heat.
- Dry welding clothing (shoes, gloves and body protection) to protect against warm environments with conditions comparable to ambient temperatures of 100 °C or higher and arcing and work on live components.
- Hearing protection against harming noise.



Explosion risk!

Apparently harmless substances in closed containers may generate excessive pressure when heated.

- Move containers with inflammable or explosive liquids away from the working area!
- Never heat explosive liquids, dusts or gases by welding or cutting!



Fire hazard!

Due to the high temperatures, sparks, glowing parts and hot slag that occur during welding, there is a risk of flames.

- Be watchful of potential sources of fire in the working area!
- Do not carry any easily inflammable objects, e.g. matches or lighters.
- Ensure suitable fire extinguishers are available in the working area!
- Thoroughly remove any residue of flammable materials from the workpiece prior to starting to weld.
- Only further process workpieces after they have cooled down. Do not allow them to contact any flammable materials!

⚠ CAUTION**Smoke and gases!**

Smoke and gases may lead to shortness of breath and poisoning! The ultraviolet radiation of the arc may also convert solvent vapours (chlorinated hydrocarbon) into poisonous phosgene.

- Ensure sufficient fresh air!
- Keep solvent vapours away from the arc beam field!
- Wear suitable respiratory protection if necessary!
- To prevent the formation of phosgene, residues of chlorinated solvents on workpieces must first be neutralised using appropriate measures.

**Noise exposure!**

Noise exceeding 70 dBA can cause permanent hearing damage!

- Wear suitable ear protection!
- Persons located within the working area must wear suitable ear protection!



According to IEC 60974-10, welding machines are divided into two classes of electromagnetic compatibility (the EMC class can be found in the Technical data) > see 8 chapter:



Class A machines are not intended for use in residential areas where the power supply comes from the low-voltage public mains network. When ensuring the electromagnetic compatibility of class A machines, difficulties can arise in these areas due to interference not only in the supply lines but also in the form of radiated interference.



Class B machines fulfil the EMC requirements in industrial as well as residential areas, including residential areas connected to the low-voltage public mains network.

Setting up and operating

When operating arc welding systems, in some cases, electro-magnetic interference can occur although all of the welding machines comply with the emission limits specified in the standard. The user is responsible for any interference caused by welding.

In order to **evaluate** any possible problems with electromagnetic compatibility in the surrounding area, the user must consider the following: (see also EN 60974-10 Appendix A)

- Mains, control, signal and telecommunication lines
- Radios and televisions
- Computers and other control systems
- Safety equipment
- The health of neighbouring persons, especially if they have a pacemaker or wear a hearing aid
- Calibration and measuring equipment
- The immunity to interference of other equipment in the surrounding area
- The time of day at which the welding work must be carried out

Recommendations for reducing interference emission

- Mains connection, e.g. additional mains filter or shielding with a metal tube
- Maintenance of the arc welding system
- Welding leads should be as short as possible and run closely together along the ground
- Potential equalization
- Earthing of the workpiece. In cases where it is not possible to earth the workpiece directly, it should be connected by means of suitable capacitors.
- Shielding from other equipment in the surrounding area or the entire welding system

**Electromagnetic fields!**

The power source can create electrical or electromagnetic fields that may impair the function of electronic systems such as EDP and CNC devices, telecommunication, power and signal lines as well as pacemakers and defibrillators.



- Follow the maintenance instructions > see 6 chapter!
- Unwind the welding leads completely!
- Shield radiation-sensitive equipment or facilities appropriately!
- The function of pacemakers may be impaired (seek medical advice if necessary).

CAUTION



Obligations of the operator!

The respective national directives and laws must be complied with when operating the machine!

- Implementation of national legislation relating to framework directive 89/391/EEC on the introduction of measures to encourage improvements in the safety and health of workers at work and associated individual guidelines.
- In particular, directive 89/655/EEC concerning the minimum safety and health requirements for the use of work equipment by workers at work.
- The regulations applicable to occupational safety and accident prevention in the country concerned.
- Setting up and operating the machine as per IEC 60974.-9.
- Brief the user on safety-conscious work practices on a regular basis.
- Regularly inspect the machine as per IEC 60974.-4.



The manufacturer's warranty becomes void if non-genuine parts are used!

- ***Only use system components and options (power sources, welding torches, electrode holders, remote controls, spare parts and replacement parts, etc.) from our range of products!***
- ***Only insert and lock accessory components into the relevant connection socket when the machine is switched off.***

Requirements for connection to the public mains network

High-performance machines can influence the mains quality by taking current from the mains network. For some types of machines, connection restrictions or requirements relating to the maximum possible line impedance or the necessary minimum supply capacity at the interface with the public network (Point of Common Coupling, PCC) can therefore apply. In this respect, attention is also drawn to the machines' technical data. In this case, it is the responsibility of the operator, where necessary in consultation with the mains network operator, to ensure that the machine can be connected.

2.4 Transport and installation

WARNING



Risk of injury due to improper handling of shielding gas cylinders!

Improper handling and insufficient securing of shielding gas cylinders can cause serious injuries!

- Observe the instructions from the gas manufacturer and any relevant regulations concerning the use of compressed air!
- Do not attach any element to the shielding gas cylinder valve!
- Prevent the shielding gas cylinder from heating up.

⚠ CAUTION**Risk of accidents due to supply lines!**

During transport, attached supply lines (mains leads, control cables, etc.) can cause risks, e.g. by causing connected machines to tip over and injure persons!

- Disconnect all supply lines before transport!

**Risk of tipping!**

There is a risk of the machine tipping over and injuring persons or being damaged itself during movement and set up. Tilt resistance is guaranteed up to an angle of 10° (according to IEC 60974-1).

- Set up and transport the machine on level, solid ground.
- Secure add-on parts using suitable equipment.

**Risk of accidents due to incorrectly installed leads!**

Incorrectly installed leads (mains, control and welding leads or intermediate hose packages) can present a tripping hazard.

- Lay the supply lines flat on the floor (avoid loops).
- Avoid laying the leads on passage ways.

**Risk of injury from heated coolant and its connections!**

The coolant used and its connection or connection points can heat up significantly during operation (water-cooled version). When opening the coolant circuit, escaping coolant may cause scalding.

- Open the coolant circuit only when the power source or cooling unit is switched off!
- Wear proper protective equipment (protective gloves)!
- Seal open connections of the hose leads with suitable plugs.



The units are designed for operation in an upright position!

Operation in non-permissible positions can cause equipment damage.

- ***Only transport and operate in an upright position!***



Accessory components and the power source itself can be damaged by incorrect connection!

- ***Only insert and lock accessory components into the relevant connection socket when the machine is switched off.***
- ***Comprehensive descriptions can be found in the operating instructions for the relevant accessory components.***
- ***Accessory components are detected automatically after the power source is switched on.***



Protective dust caps protect the connection sockets and therefore the machine against dirt and damage.

- ***The protective dust cap must be fitted if there is no accessory component being operated on that connection.***
- ***The cap must be replaced if faulty or if lost!***

3 Intended use

WARNING



Hazards due to improper usage!

The machine has been constructed to the state of the art and any regulations and standards applicable for use in industry and trade. It may only be used for the welding procedures indicated at the rating plate. Hazards may arise for persons, animals and material objects if the equipment is not used correctly. No liability is accepted for any damages arising from improper usage!

- The equipment must only be used in line with its designated purpose and by trained or expert personnel!
- Do not improperly modify or convert the equipment!

3.1 Applications

Arc welding machine for GMAW standard welding and in the secondary process TIG welding with Liftarc (contact ignition) or MMA welding. Accessory components may expand the range of functions (see the relevant documentation in the chapter of the same name).

3.2 Software version

The software version of the machine control can be displayed in the machine configuration menu (menu *Srv*) > see 5.7 chapter.

3.3 Documents which also apply

3.3.1 Warranty

For more information refer to the "Warranty registration" brochure supplied and our information regarding warranty, maintenance and testing at www.ewm-group.com!

3.3.2 Declaration of Conformity



This product corresponds in its design and construction to the EU directives listed in the declaration. The product comes with a relevant declaration of conformity in the original.

The manufacturer recommends carrying out the safety inspection according to national and international standards and guidelines every 12 months (from commissioning).

3.3.3 Welding in environments with increased electrical hazards



Power sources with this marking can be used for welding in an environment with increased electrical hazard (e.g. boilers). For this purpose, appropriate national or international regulations must be followed. The power source must not be placed in the danger zone!

3.3.4 Service documents (spare parts and circuit diagrams)

WARNING



No improper repairs and modifications!

To prevent injuries and damage to the machine, only competent personnel (authorised service personnel) are allowed to repair or modify the machine.

Unauthorised manipulations will invalidate the warranty!

- Instruct competent personnel (authorised service personnel) to repair the machine.

Original copies of the circuit diagrams are enclosed with the unit.

Spare parts can be obtained from the relevant authorised dealer.

3.3.5 Calibration/Validation

An original certificate is enclosed with the product. The manufacturer recommends calibration / validation at intervals of 12 months (from commissioning).

3.3.6 Part of the complete documentation

This document is part of the complete documentation and valid only in combination with all other parts of these instructions! Read and observe the operating instructions for all system components, especially the safety instructions!

The illustration shows a general example of a welding system.

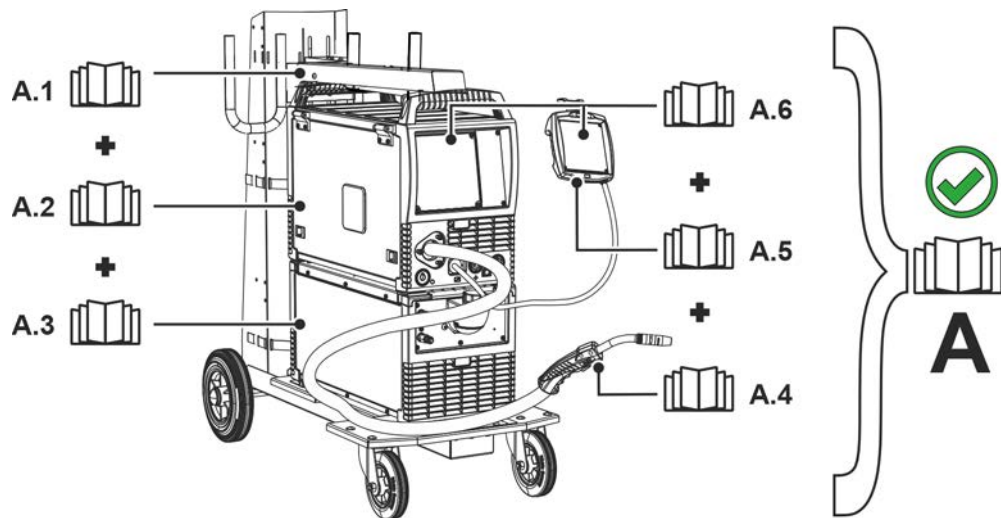

Figure 3-1

Item	Documentation
A.1	Transport vehicle
A.2	Power source
A.3	Cooling unit
A.4	Welding torch
A.5	Remote control
A.6	Control
A	Complete documentation

4 Machine description – quick overview

4.1 Front view / rear view

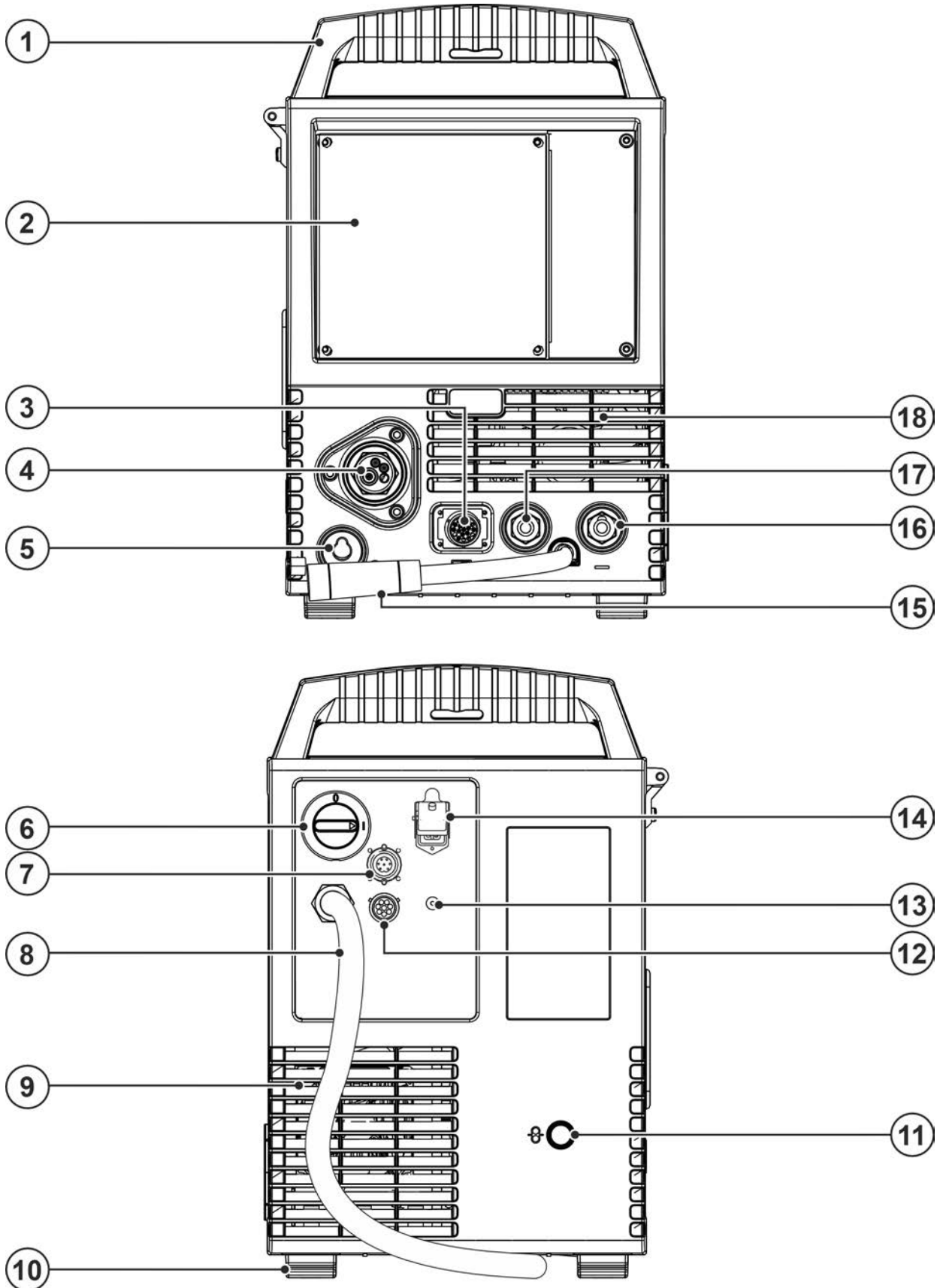











Figure 4-1

Item	Symbol	Description
1		Carrying handle
2		Machine control > see 4.3 chapter
3		19-pole connection socket - analogue For connecting analogue accessory components (remote control, welding torch control lead, etc.)
4		Welding torch connection - Euro or Dinse torch connector Welding current, shielding gas and torch trigger integrated
5		Park socket - polarity selection plug Retainer for the polarity selection plug in MMA mode or for transport.
6		Main Switch Switching the machine on or off.
7		Connection socket- 7-pole (digital) - optional Connection capability for Xnet LAN/Wi-Fi gateway > see 9 chapter
8		Mains connection cable > see 5.1.7 chapter
9		Cooling air outlet
10		Machine feet
11		External wire feed inlet Pre-cut casing inlet for external wire feed.
12		8-pole connection socket Cooling unit control lead
13		Connection thread - G$\frac{1}{4}$" Shielding gas connection (inlet)
14		4-pole connection socket Cooling unit voltage supply
15		Welding current cable polarity selection Welding current to Euro torch connector/torch, for polarity selection <ul style="list-style-type: none"> •-----MIG/MAG: Connection socket for "+" welding current •-----Self-shielding flux cored wire/TIG: Connection socket, "-" welding current •-----MMA: Park socket
16		Connection socket (-) welding current How to connect the accessories depends on the welding procedure. Please observe the connection description for the corresponding welding procedure > see 5 chapter.
17		Connection socket (+) welding current How to connect the accessories depends on the welding procedure. Please observe the connection description for the corresponding welding procedure > see 5 chapter.
18		Cooling air inlet

4.2 Inside view

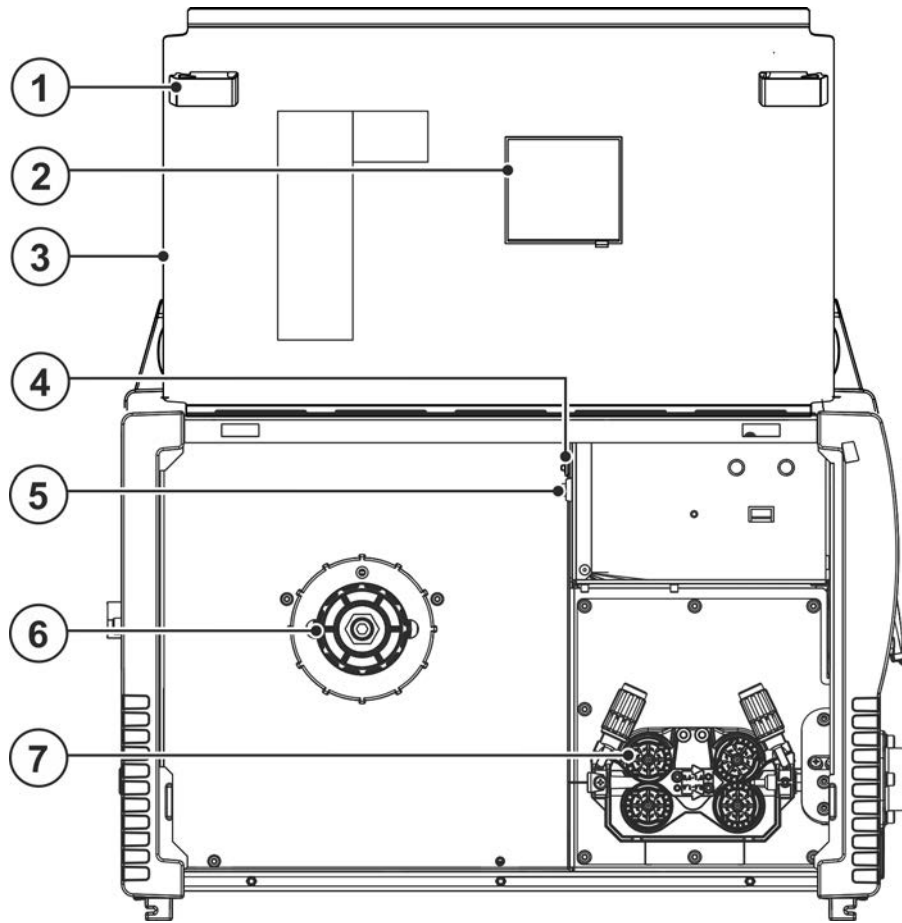



Figure 4-2

Item	Symbol	Description
1		Slide latch - lock for the protective cap
2		Wire spool inspection window Check wire supply
3		Protective cap Cover for the wire feed mechanism and other operating elements. Depending on the machine series, additional stickers with information on the replacement parts and JOB lists will be located on the inside.
4		Key button, Automatic cutout Wire feed motor supply voltage fuse (press to reset a triggered fuse)
5		Push-button wire inching Potential- and gas-free inching of the wire electrode through the hose package to the welding torch > see 5.2.4.3 chapter.
6		Wire spool holder
7		Wire feed unit > see 5.2.4 chapter

4.3 Machine control – Operating elements

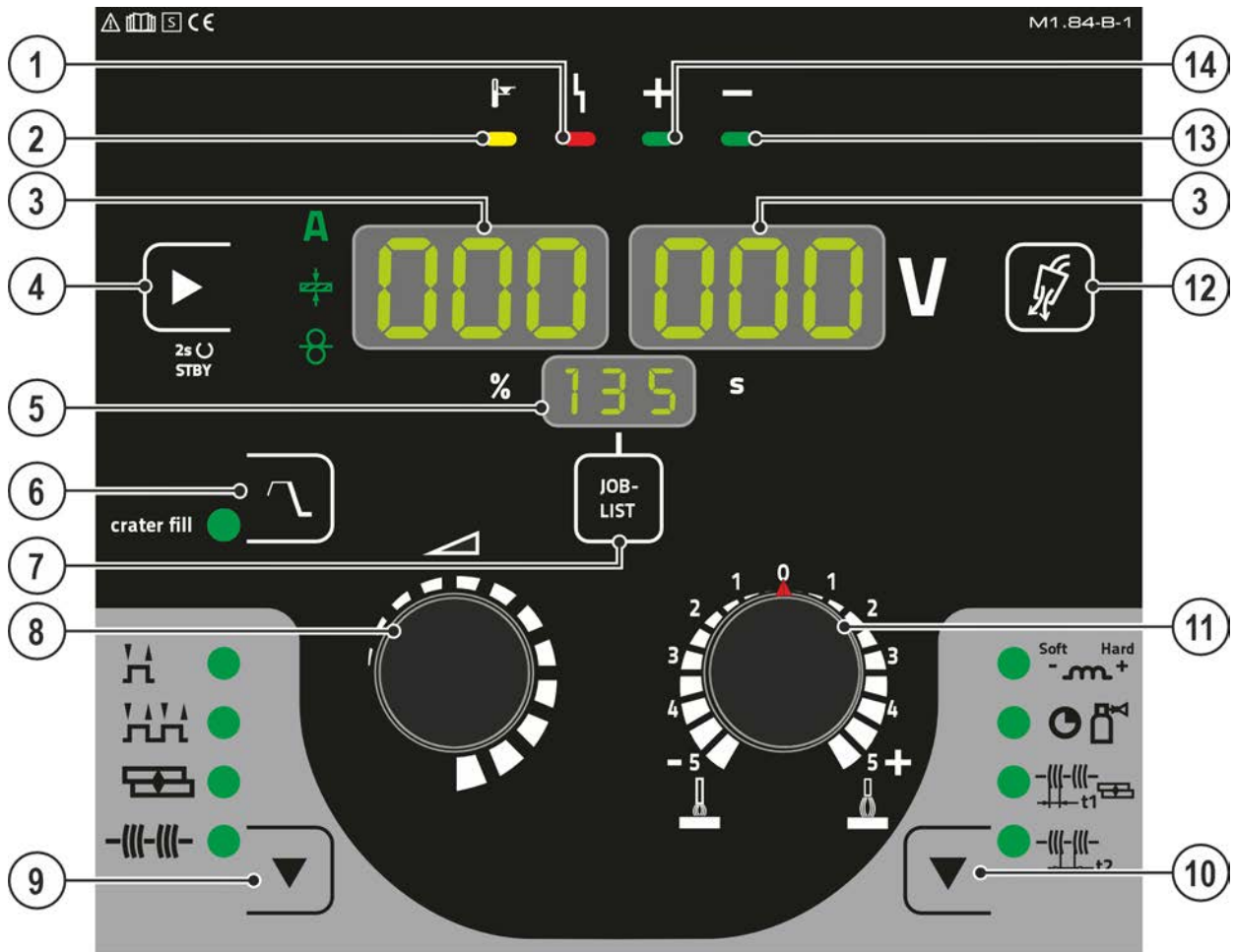

Figure 4-3

Item	Symbol	Description
1		“Collective interference” signal light
2		“Excess temperature” signal light
3		Welding data display 3-digit Displays the welding parameters and the corresponding values > see 4.3.1 chapter
4		Push-button for welding parameter display mode / power-saving mode A ----- Welding current + ----- Material thickness ⊗ ----- Wire feed speed Press for 2 s to put the machine into power-saving mode. To reactivate, operate any control element > see 5.7.3 chapter.
5		Display JOB Shows the currently selected welding task (JOB number).
6		Crater fill push-button (crater fill) After the selection, additional parameters for the end crater filling are active that you can set in the expert menu > see 5.2.13 chapter. The status is saved in the machine regardless of the selected JOB.
7	JOB-LIST	Welding task push-button (JOB) Select the welding task from the welding task list (JOB-LIST). The list can be found inside the protective cap on the wire feeder and in the appendix to these operating instructions.

Item	Symbol	Description
8		Welding parameter setting dial For setting the welding performance, for selecting the JOB (welding task) and for setting other welding parameters.
9		Operating mode button H----- Non-latched HH----- Latched ----- Spots ----- Interval
10		Runtime parameters button For selecting the parameters to be set. Also for entering and exiting the menus for advanced settings. ----- Choke effect/dynamics ----- Gas post-flow time ----- Spot time ----- Pause time
11		Rotary knob for correcting the arc length (voltage correction)
12		Gas test push-button > see 5.1.9 chapter
13		Signal light polarity setting
14		Signal light polarity setting

4.3.1 Welding data display

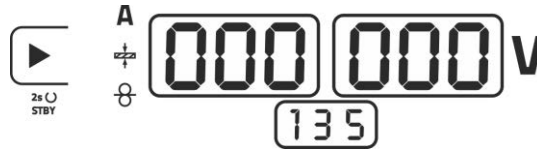

Figure 4-4

Next to the display is the push-button for the welding parameter display mode.

Each time you press the push-button, the display changes to the following parameter. After the last parameter, the display continues with the first parameter.

The display shows:

- Nominal value (before welding)
- Actual value (during welding)
- Hold value (after welding)

MIG/MAG welding

Parameter	Nominal value	Actual value	Hold value
Welding current	<input checked="" type="checkbox"/> / <input type="checkbox"/> ^[1]	<input checked="" type="checkbox"/>	<input checked="" type="checkbox"/>
Material thickness	<input checked="" type="checkbox"/>	<input type="checkbox"/>	<input type="checkbox"/>
Wire feed speed	<input checked="" type="checkbox"/>	<input type="checkbox"/>	<input type="checkbox"/>
Welding voltage	<input checked="" type="checkbox"/>	<input checked="" type="checkbox"/>	<input checked="" type="checkbox"/>

^[1] MIG/MAG conventional

TIG welding or MMA welding

Parameter	Nominal value	Actual value	Hold value
Welding current	<input checked="" type="checkbox"/>	<input type="checkbox"/>	<input type="checkbox"/>
Welding voltage	<input type="checkbox"/>	<input checked="" type="checkbox"/>	<input checked="" type="checkbox"/>

After welding, the display switches from hold value values to nominal values by

- pressing the push-buttons or turning the rotary knobs of the control or
- waiting for 5 seconds.

4.3.1.1 Polarity setting

The polarity setting displays the polarity required for the selected JOB on the machine control > see 4.3 chapter. The required polarity can then be set with the polarity selection plug.

5 Design and function

⚠ WARNING



Risk of injury from electrical voltage!

Contact with live parts, e.g. power connections, can be fatal!

- Observe the safety information on the first pages of the operating instructions!
- Commissioning must be carried out by persons who are specifically trained in handling power sources!
- Connect connection or power cables while the machine is switched off!

Read and observe the documentation to all system and accessory components!

5.1 Transport and installation

⚠ WARNING



Risk of accident due to improper transport of machines that must not be lifted!

Do not lift or suspend the machine! The machine can drop and cause injuries! The handles, straps or brackets are suitable for transport by hand only!

- The machine must not be suspended or lifted using a crane.



Damage to the machine due to improper transport!

The machine can be damaged by tensile or lateral forces if it is set down or picked up in a non-vertical position!

- **Do not drag the machine horizontally on the machine feet!**
- **Always pick up the machine vertically and set it down carefully.**

5.1.1 Ambient conditions



The machine must not be operated in the open air and must only be set up and operated on a suitable, stable and level base!

- **The operator must ensure that the ground is non-slip and level, and provide sufficient lighting for the place of work.**
- **Safe operation of the machine must be guaranteed at all times.**



Machine damage due to contamination!

Unusually high amounts of dust, acid, corrosive gas or substances may damage the machine (note the maintenance intervals > see 6.3 chapter).

- **Prevent high amounts of smoke, weld spatter, steam, oil vapour, grinding dust and corrosive ambient air from developing!**

In operation

Temperature range of the ambient air:

- -25 °C to +40 °C (-13 °F to 104 °F) ^[1]

Relative humidity:

- up to 50 % at 40 °C (104 °F)
- up to 90 % at 20 °C (68 °F)

Transport and storage

Storage in a closed room, temperature range of the ambient air:

- -30 °C to +70 °C (-22 °F to 158 °F) ^[1]

Relative humidity

- up to 90 % at 20 °C (68 °F)

^[1] Ambient temperature dependent on coolant! Observe the coolant temperature range of the torch cooling

5.1.2 Machine cooling



Insufficient ventilation results in a reduction in performance and equipment damage.

- **Observe the ambient conditions!**
- **Keep the cooling air inlet and outlet clear!**
- **Observe the minimum distance of 0.5 m from obstacles!**

5.1.3 Workpiece lead, general

⚠ CAUTION



Risk of burning due to incorrect welding current connection!

If the welding current plugs (machine connections) are not locked or if the workpiece connection is contaminated (paint, corrosion), these connections and leads can heat up and cause burns when touched!

- Check welding current connections on a daily basis and lock by turning to the right when necessary.
- Clean workpiece connection thoroughly and secure properly. Do not use structural parts of the workpiece as welding current return lead!

5.1.4 Welding torch cooling system

5.1.4.1 Cooling unit connection

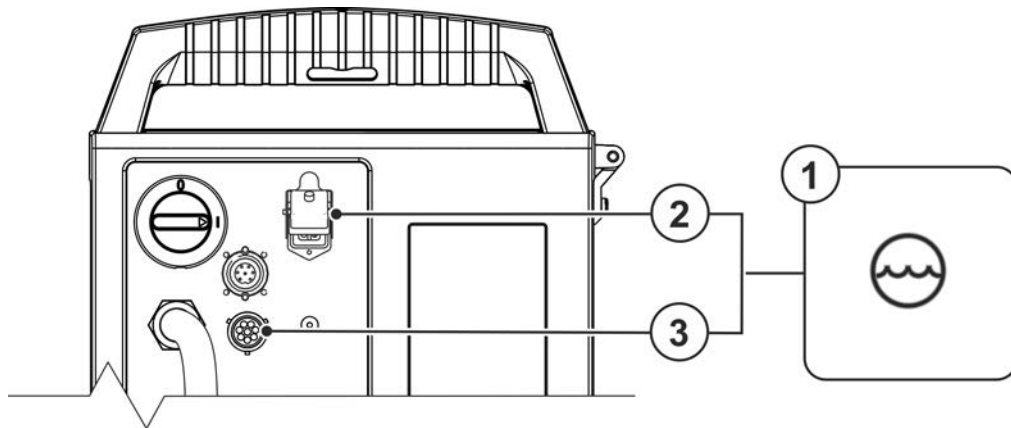

Figure 5-1

Item	Symbol	Description
1		Cooling module
2		4-pole connection socket Cooling unit voltage supply
3		8-pole connection socket Cooling unit control lead

- Insert and lock the 4-pole supply plug on the cooling unit into the 4-pole connection socket on the welding machine.
- Insert and lock the 8-pole control lead plug on the cooling unit into the 8-pole connection socket on the welding machine.

5.1.5 Notes on the installation of welding current leads

- Incorrectly installed welding current leads can cause faults in the arc (flickering).
- Lay the workpiece lead and hose package of power sources without HF igniter (MIG/MAG) for as long and as close as possible in parallel.
- Lay the workpiece lead and hose package of power sources with HF igniter (TIG) for as long as possible in parallel with a distance of 20 cm to avoid HF sparkover.
- Always keep a distance of at least 20 cm to leads of other power sources to avoid interferences
- Always keep leads as short as possible! For optimum welding results max. 30 m (welding lead + intermediate hose package + torch lead).

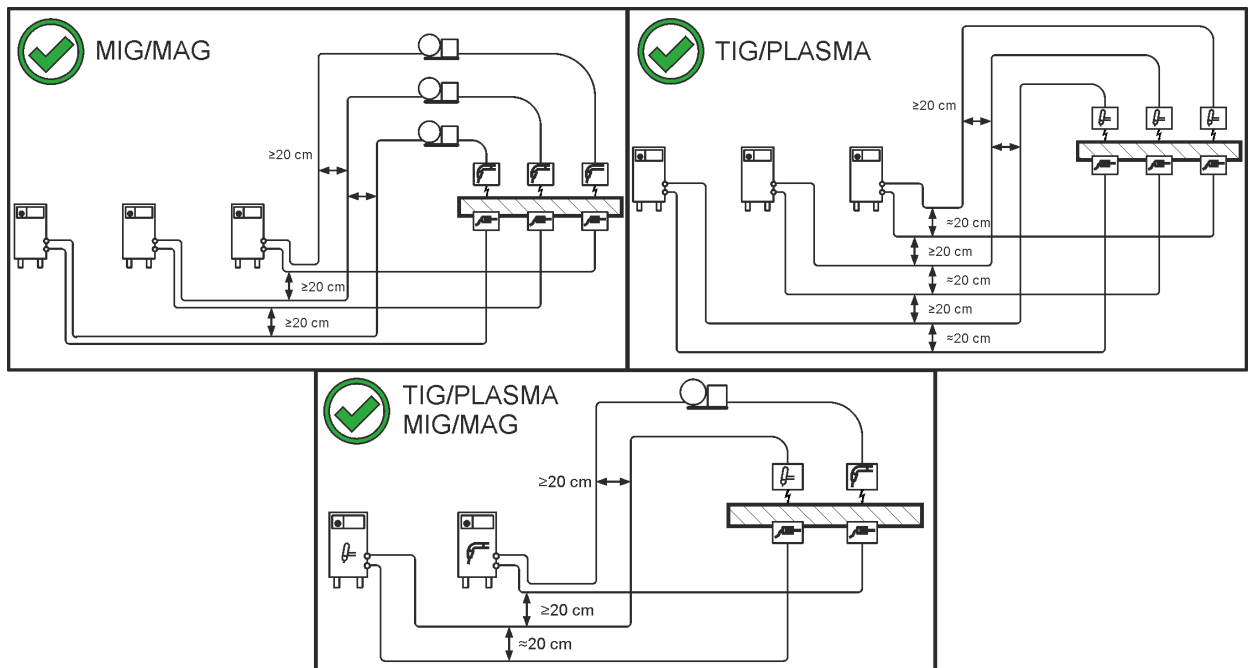

Figure 5-2

- Use an individual welding lead to the workpiece for each welding machine!

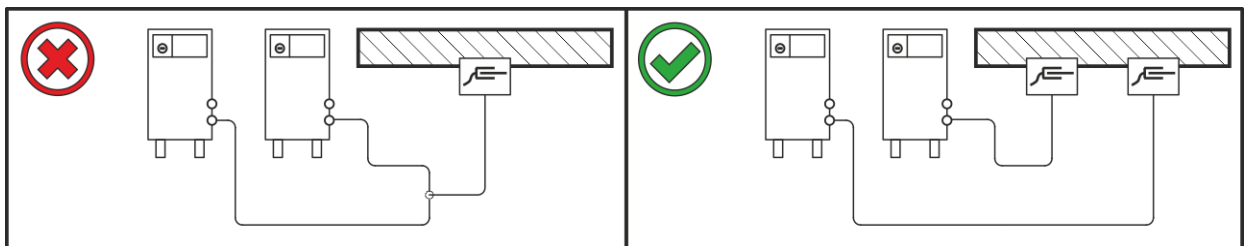

Figure 5-3

- Fully unroll welding current leads, torch hose packages and intermediate hose packages. Avoid loops!
- Always keep leads as short as possible!

Lay any excess cable lengths in meanders.

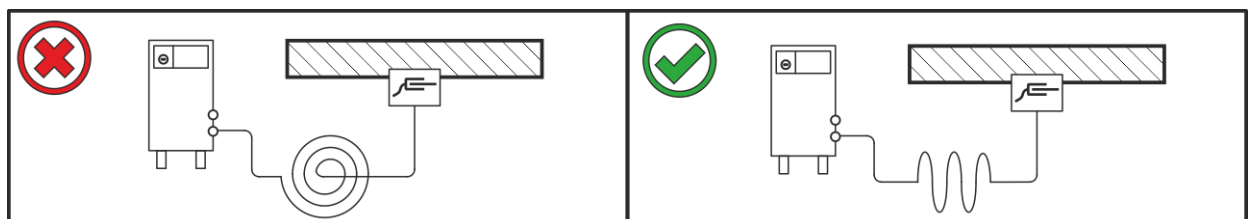

Figure 5-4

5.1.6 Stray welding currents

⚠ WARNING



Risk of injury due to stray welding currents!

Stray welding currents can destroy protective earth conductors, damage machines and electronic devices and cause overheating of components, leading to fire.

- Check that all welding current connections are firmly secured and electrical connections are in perfect condition.
- Set up, attach or suspend all conductive power source components such as casing, transport vehicles and crane frames so they are insulated.
- Do not place any other electronic devices such as drills or angle grinders on the power source, transport vehicle or crane frames unless they are insulated.
- Always put welding torches and electrode holders on an insulated surface when they are not in use.

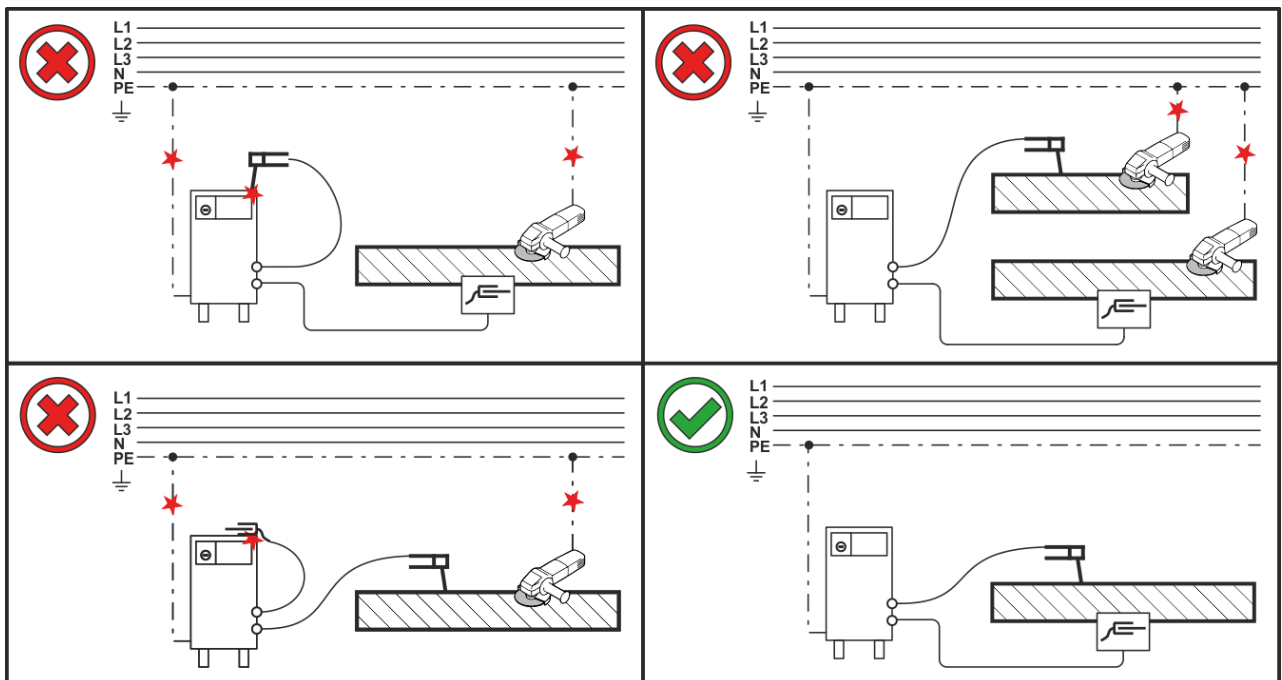

Figure 5-5

5.1.7 Mains connection

DANGER



Hazards caused by improper mains connection!

An improper mains connection can cause injuries or damage property!

- The connection (mains plug or cable), the repair or voltage adjustment of the device must be carried out by a qualified electrician in accordance with the respective local laws or national regulations!
- The mains voltage indicated on the rating plate must match the supply voltage.
- Only operate machine using a socket that has correctly fitted protective earth.
- Mains plug, socket and lead must be checked by a qualified electrician on a regular basis!
- When operating the generator, always ensure it is earthed as stipulated in the operating instructions. The network created must be suitable for operating machines according to protection class I.

5.1.7.1 Mains configuration

The machine may be connected to:

- a three-phase system with four conductors and an earthed neutral conductor
- a three-phase system with three conductors of which any one can be earthed, e.g. the outer conductor

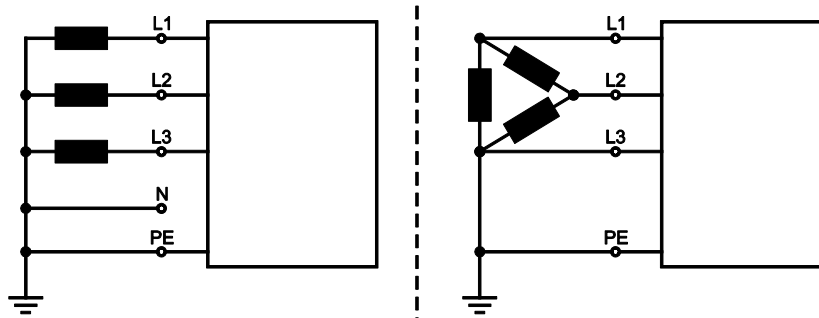

Figure 5-6

Legend

Item	Designation	Colour code
L1	Outer conductor 1	brown
L2	Outer conductor 2	black
L3	Outer conductor 3	grey
N	Neutral conductor	blue
PE	Protective conductor	green-yellow

- Insert mains plug of the switched-off machine into the appropriate socket.

5.1.8 Welding torch holder

The item described in the following is part of the machine's scope of delivery.

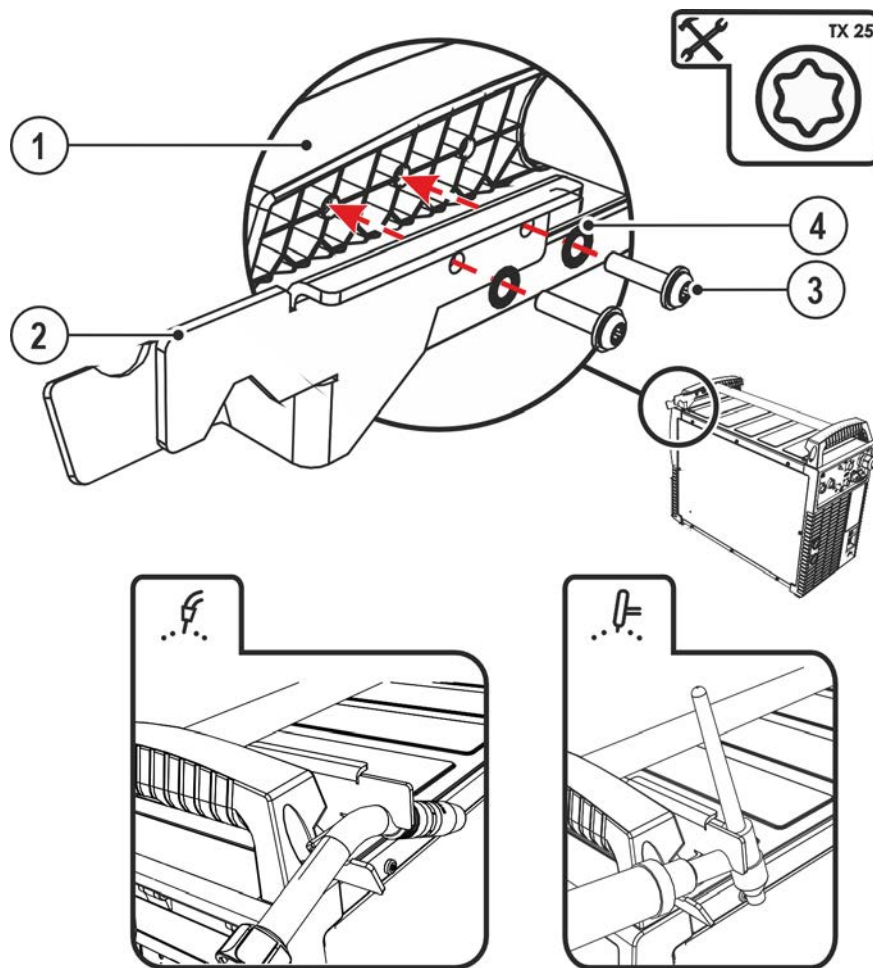



Figure 5-7

Item	Symbol	Description
1		Crossmember of the transport handle
2		Torch holder
3		Fixing screws (x 4)
4		Fan-type lock washers

- Use the mounting screws to screw the torch holder onto the crossmember of the transport handle.
- Insert the welding torch into the welding torch holder as shown.

5.1.9 Shielding gas supply (shielding gas cylinder for welding machine)

⚠ WARNING



Risk of injury due to improper handling of shielding gas cylinders! Improper handling and insufficient securing of shielding gas cylinders can cause serious injuries!

- Place shielding gas cylinder into the designated holder and secure with fastening elements (chain/belt)!
- Attach the fastening elements within the upper half of the shielding gas cylinder!
- The fastening elements must tightly enclose the shielding gas cylinder!

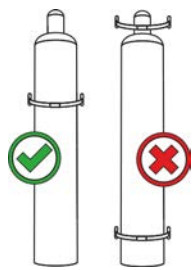



An unhindered shielding gas supply from the shielding gas cylinder to the welding torch is a fundamental requirement for optimum welding results. In addition, a blocked shielding gas supply may result in the welding torch being destroyed.

- **Always re-fit the yellow protective cap when not using the shielding gas connection.**
- **All shielding gas connections must be gas tight.**

5.1.9.1 Pressure regulator connection

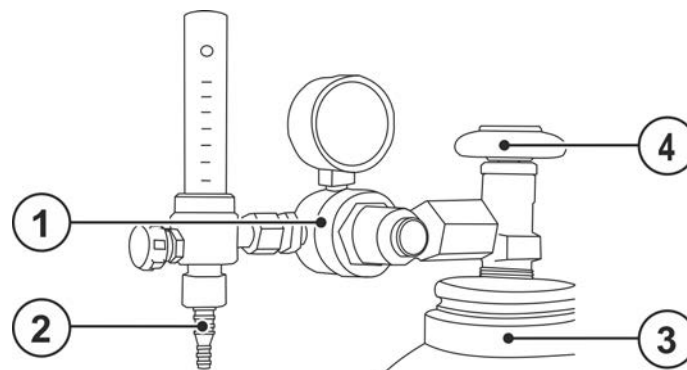

Figure 5-8

Item	Symbol	Description
1		Pressure regulator
2		Output side of the pressure regulator
3		Shielding gas cylinder
4		Cylinder valve

- Before connecting the pressure regulator to the gas cylinder, open the cylinder valve briefly to blow out any dirt.
- Tighten the pressure regulator screw connection on the gas bottle valve to be gas-tight.
- Screw the gas hose connection to the outlet side of the pressure regulator gas-tight.

5.1.9.2 Shielding gas hose connection

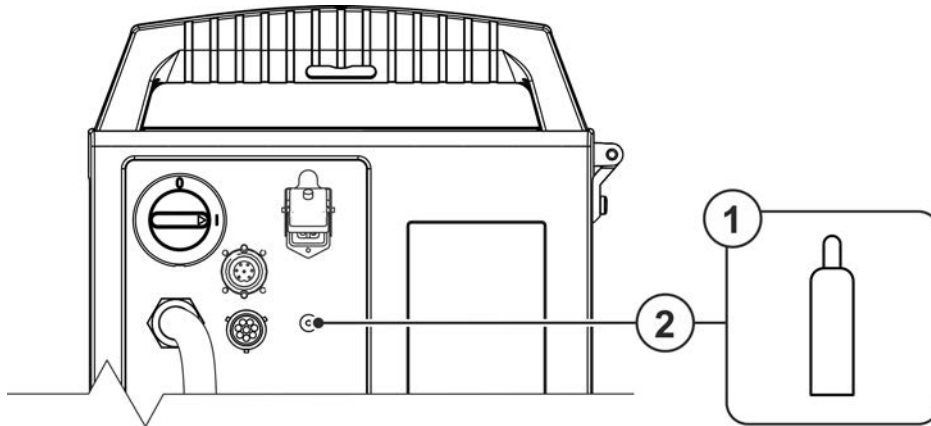

Figure 5-9

Item	Symbol	Description
1		Shielding gas cylinder / pressure regulator
2		Connection thread - G $\frac{1}{4}$ " Shielding gas connection (inlet)

- Screw the gas hose connection to the shielding gas connection (inlet) on the machine gas-tight.

5.1.9.3 Shielding gas volume settings

If the shielding gas setting is too low or too high, this can introduce air to the weld pool and may cause pores to form. Adjust the shielding gas quantity to suit the welding task!

- Slowly open the gas cylinder valve.
- Open the pressure regulator.
- Switch on the power source at the main switch.
- Trigger gas test > see 5.1.9.4 chapter function (welding voltage and wire feed motor remain switched off – no accidental arc ignition).
- Set the relevant gas quantity for the application on the pressure regulator.

Setting instructions

Welding process	Recommended shielding gas quantity
MAG welding	Wire diameter x 11.5 = l/min
MIG brazing	Wire diameter x 11.5 = l/min
MIG welding (aluminium)	Wire diameter x 13.5 = l/min (100 % argon)
TIG	Gas nozzle diameter in mm corresponds to l/min gas throughput

Helium-rich gas mixtures require a higher gas volume!

The table below can be used to correct the gas volume calculated where necessary:

Shielding gas	Factor
75% Ar/25% He	1.14
50% Ar/50% He	1.35
25% Ar/75% He	1.75
100% He	3.16

5.1.9.4 Gas test

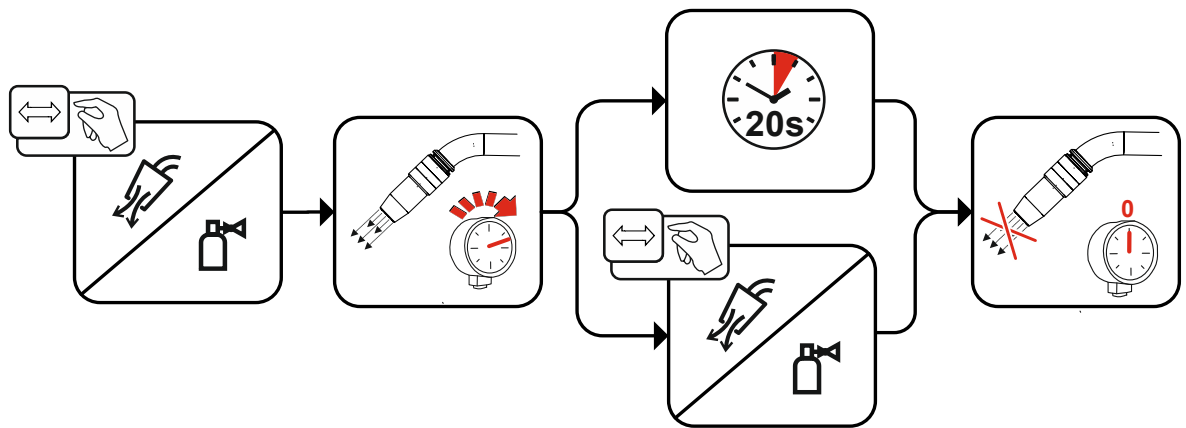

Figure 5-10

5.2 MIG/MAG welding

5.2.1 Welding torch and workpiece line connection

On delivery, the Euro torch connector is fitted with a capillary tube for welding torches with a steel liner. Conversion is necessary if a welding torch with a liner is used!

- Operate welding torches with a liner > with a guide tube.
- Operate welding torches with a steel liner > with a capillary tube.

For connection, observe the operating instructions for the welding torch.

Depending on the wire electrode diameter or type, either a steel liner or liner with the correct inner diameter must be inserted in the torch!

Recommendation:

- Use a steel liner when welding hard, unalloyed wire electrodes (steel).
- Use a chrome nickel liner when welding hard, high-alloy wire electrodes (CrNi).
- Use a plastic or teflon liner when welding or brazing soft wire electrodes, high-alloy wire electrodes or aluminium materials.

Preparation for connecting welding torches with a spiral guide:

- Check that the capillary tube is correctly positioned in relation to the central connector!

Preparation for connecting welding torches with a liner:

- Push forward the capillary tube on the wire feed side in the direction of the Euro torch connector and remove it there.
- Insert the liner guide tube from the Euro torch connector side.
- Carefully insert the welding torch connector with as yet too long a liner into the Euro torch connector and secure with a crown nut.
- Cut off the liner with a liner cutter > see 9 chapter just before the wire feed roller.
- Loosen the welding torch connector and remove.
- Carefully chamfer the cut off end of the liner with a liner sharpener > see 9 chapter and sharpen.

Some wire electrodes (e.g. self-shielding cored wire) are welded using negative polarity. In this case, the welding current lead should be connected to the "-" welding current socket, and the workpiece lead should be connected to the "+" welding current socket. Observe the information from the electrode manufacturer!

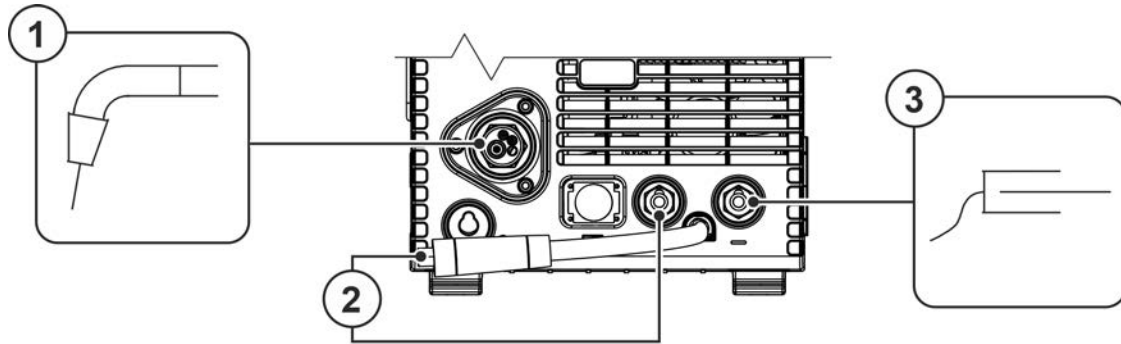

Figure 5-11

Item	Symbol	Description
1		Welding torch
2		Polarity selector plug welding current cable Internal welding current cable for central connection/welding torch. • Connection socket for (+) welding current
3		Workpiece

- Insert the polarity selection plug into the "+" welding current connection socket and lock in place by turning to the right.
- Insert the central plug for the welding torch into the central connector and screw together with crown nut.
- Insert cable plug on the workpiece lead into the "-" welding current socket and lock by turning to the right.

Where applicable:

- Insert the welding torch control cable into the 19-pole connection socket and lock (MIG/MAG torches with additional control cables only).
- Lock connecting nipples of the cooling water tubes into the corresponding quick connect couplings: Return line red to quick connect coupling, red (coolant return) and supply line blue to quick connect coupling, blue (coolant supply).

5.2.2 MIG/MAG function torch

The torch trigger on the MIG welding torch is generally used to start and finish the welding process. Function torches feature additional operating elements to set the wire feed speed and voltage correction. Welding torches with one rotary knob, one rocker or one pair of buttons only must be configured on the machine control appropriately. For this purpose, set the FRC special parameter to the corresponding accessory component > see 5.6 chapter.

5.2.3 MIG/MAG Push/Pull welding torch

Pin assignment

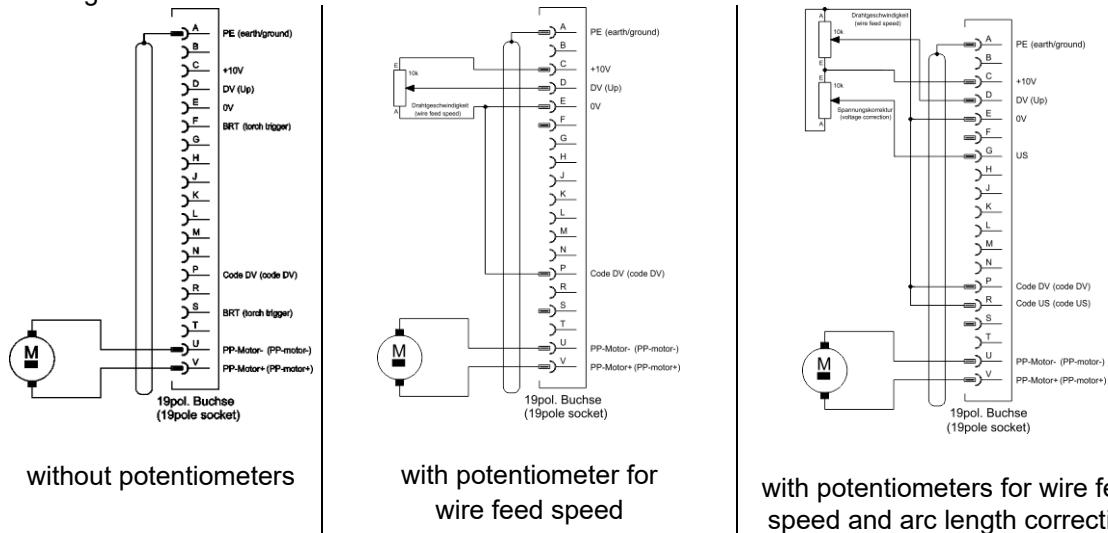

Figure 5-12

5.2.4 Wire feed

⚠ CAUTION



Risk of injury due to moving parts!

The wire feeders are equipped with moving parts, which can trap hands, hair, clothing or tools and thus injure persons!

- Do not reach into rotating or moving parts or drive components!
- Keep casing covers or protective caps closed during operation!



Risk of injury due to welding wire escaping in an unpredictable manner!

Welding wire can be conveyed at very high speeds and, if conveyed incorrectly, may escape in an uncontrolled manner and injure persons!

- Before mains connection, set up the complete wire guide system from the wire spool to the welding torch!
- Check wire guide at regular intervals!
- Keep all casing covers or protective caps closed during operation!

5.2.4.1 Inserting the wire spool

⚠ CAUTION



Risk of injury due to incorrectly secured wire spool.

If the wire spool is not secured properly, it may come loose from the wire spool support and fall to the ground, causing damage to the machine and injuries.

- Make sure to correctly fasten the wire spool to the wire spool support.
- Before you start working, always check the wire spool is securely fastened.

Standard D300 wire spool holder can be used. Adapters are required when using standardised basket coils (DIN 8559) > see 9 chapter.

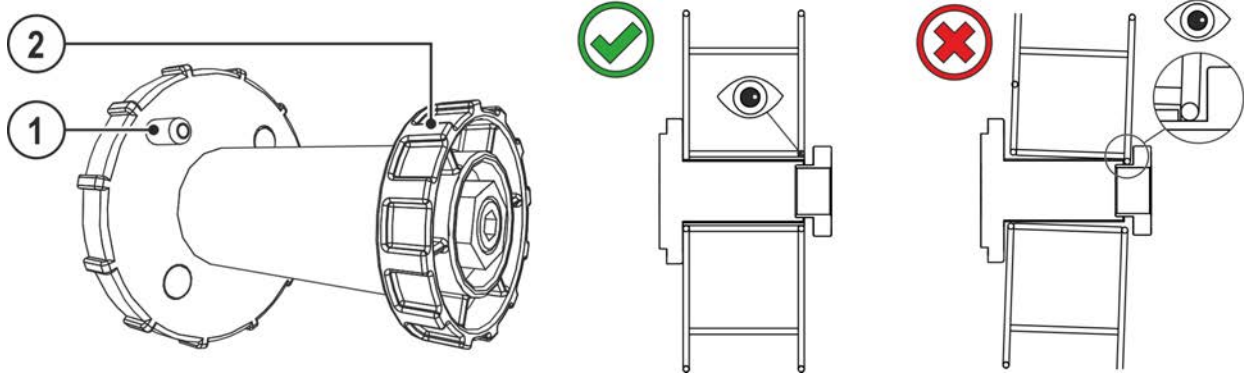

Figure 5-13

Item	Symbol	Description
1		Carrier pin For fixing the wire spool
2		Knurled nut For fixing the wire spool

- Unlock and open protective flap.
- Loosen knurled nut from spool holder.
- Fix welding wire reel onto the spool holder so that the carrier pin locks into the spool bore.
- Fasten wire spool using knurled nut.

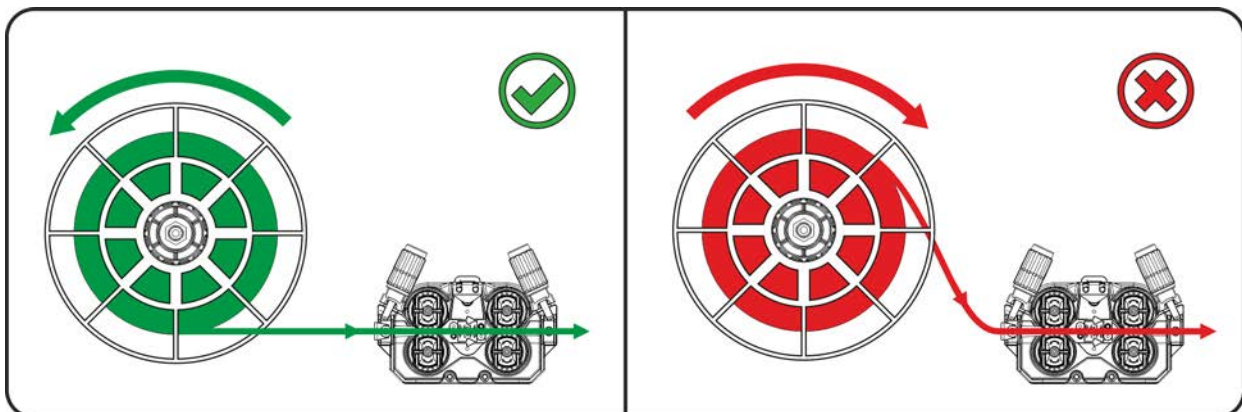

Figure 5-14

Observe the unwinding direction of the wire spool.

5.2.4.2 Changing the wire feed rollers

Figure 5-15

Item	Symbol	Description
1		Tommy The tommy is used to secure the closure brackets of the wire feed rollers.
2		Closure bracket The closure brackets are used to secure the wire feed rollers.
3		Feed roll tensioner Fixing the clamping unit and setting the pressure.
4		Clamping unit
5		Wire feed roller see the Wire feed roller overview table

- Rotate the tommy by 90° clockwise or anti-clockwise (tommy locks into place).
- Fold the closure brackets outwards by 90°.
- Unfasten pressure units and fold out (clamping units and pressure rollers will automatically flip upwards).
- Remove the wire feed rollers from the roller support.
- Select new wire feed rollers according to the Wire feed roller overview table and reassemble the wire feed mechanism in reverse order.

Unsatisfactory welding results due to faulty wire feeding!

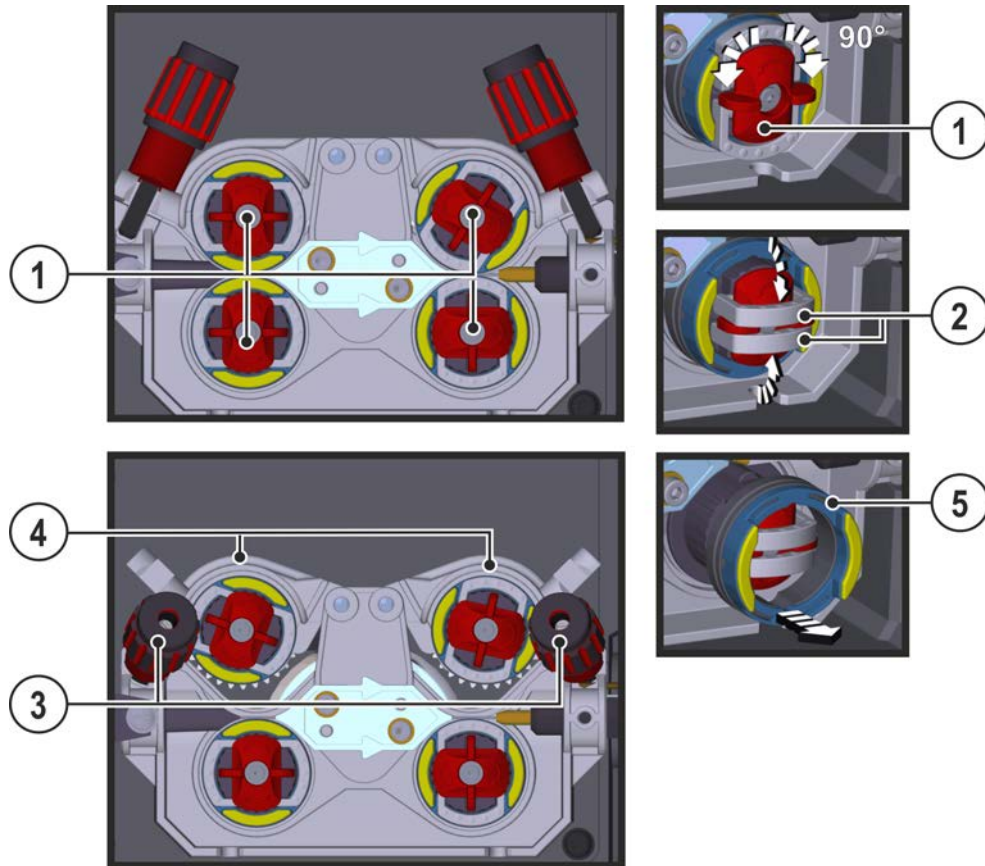
The wire feed rolls must be suitable for the diameter of the wire and the material. The wire feed rolls are colour-coded to facilitate distinction (see the Wire feed roll overview table). When working with a wire diameter of > 1.6 mm the drive has to be converted for the wire feed kit ON WF 2,0-3,2MM EFEED > see 10 chapter.

Wire feed roll overview table:

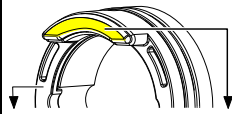
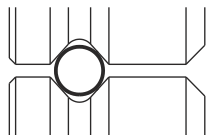
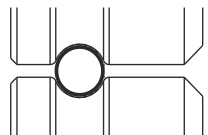
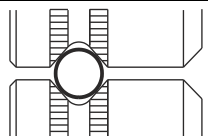
Material	Diameter		Colour code			Groove form
	Ø mm	Ø inch				
Steel Stainless steel Brazing	0.6	.024	monochrome	light pink	-	 V-groove
	0.8	.031		white		
	0.8	.031	bicolour	white	blue	
	0.9	.035				
	1.0	.039				
	1.0	.039		blue	red	
	1.2	.047				
	1.4	.055	monochrome	green	-	
	1.6	.063		black		
	2.0	.079		grey		
2.4	.094	brown				
2.8	.110	light green				
3.2	.126	purple				
Aluminium	0.8	.031	bicolour	white	yellow	 U-groove
	0.9	.035		blue		
	1.0	.039				
	1.2	.047		red		
	1.6	.063		black		
	2.0	.079		grey		
	2.4	.094		brown		
	2.8	.110		light green		
	3.2	.126		purple		
Flux cored wire	0.8	.031	bicolour	white	orange	 V-groove, knurled
	0.9	.035		blue		
	1.0	.039				
	1.2	.047		red		
	1.4	.055		green		
	1.6	.063		black		
	2.0	.079		grey		
	2.4	.094		brown		

5.2.4.3 Inching the wire electrode

⚠ CAUTION



Risk of injury due to welding wire escaping from the welding torch!
The welding wire can escape from the welding torch at high speed and cause bodily injury including injuries to the face and eyes!

- Never direct the welding torch towards your own body or towards other persons!



Improper contact pressure increases wear on the wire feed rolls.
Adjust the contact pressure on the adjusting nuts of the feed roll tensioners so that the wire electrode is fed but slips when the wire spool is blocked.

The inching speed is infinitely adjustable by simultaneously pressing the wire inching push-button and turning the wire speed rotary knob. The left display shows the wire feed speed selected, the right display shows the current motor current of the wire feed mechanism. Depending on the design of the device, the wire feed mechanism may be reversed!

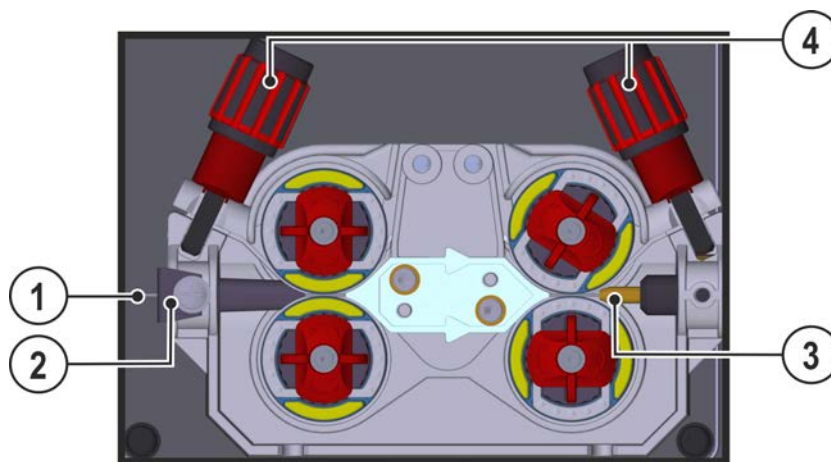

Figure 5-16

Item	Symbol	Description
1		Welding wire
2		Wire feed nipple
3		Guide tube
4		Adjusting nut

- Extend and lay out the torch hose package.
- Carefully unwind the welding wire from the wire spool and insert through the wire feed nipples up to the wire feed rollers.
- Press the inching push-button (the drive catches the welding wire and automatically guides it to the welding torch outlet) > see 4.2 chapter.

A prerequisite for the automatic inching process is the correct preparation of the wire guide, especially in the capillary and wire guide tube area > see 5.2.1 chapter.

- The contact pressure has to be adjusted separately for each side (wire inlet/outlet) at the feed roll tensioner setting nuts depending on the welding consumable used. A table with the setting values can be found on a sticker near the wire drive.

Version 1: right hand mounting

Version 2: left hand mounting

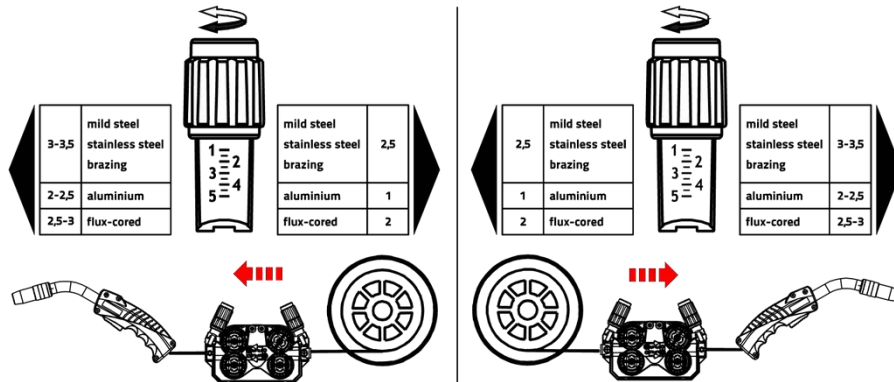

Figure 5-17

Automatic inching stop

Touch the welding torch against the workpiece during inching. Inching of the welding wire will stop as soon it touches the workpiece.

5.2.4.4 Spool brake setting

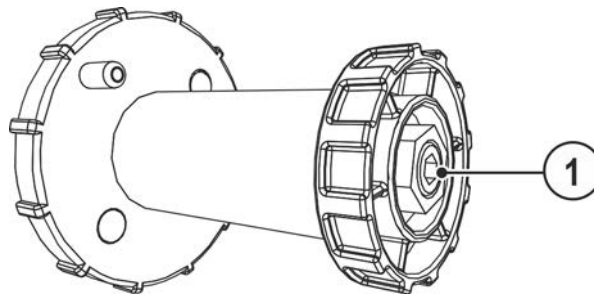

Figure 5-18

Item	Symbol	Description
1		Allen screw Securing the wire spool retainer and adjustment of the spool brake

- Tighten the Allen screw (8 mm) in the clockwise direction to increase the braking effect.

Tighten the spool brake until the wire spool no longer turns when the wire feed motor stops but without it jamming during operation!

5.2.5 Definition of MIG/MAG welding tasks

This machine series offers simple operation and a wide range of functions.

- JOBs (welding tasks consisting of welding procedure, type of material, wire diameter and type of shielding gas) pre-defined for all standard welding tasks.
- Simple JOB selection from a list of pre-defined JOBs (sticker on the machine).
- The system calculates the required process parameters depending on the operating point specified (one-knob operation over the rotary knob for wire feed speed).
- Conventional welding task definition using the wire feed speed and welding voltage are also possible > see 5.2.8 chapter.

The welding task definition described below applies when defining MIG/MAG and cored wire welding tasks.

Pay attention to the signal light for the polarity setting!

It may be necessary to change the welding current polarity depending on the JOB selected or the welding process.

- Reconnect the polarity selection plug if necessary.

5.2.6 Welding task selection

The following steps have to be carried out to select the welding job:

- Select basic parameters (material type, wire diameter and shielding gas type) and welding procedures (select and enter JOB number by means of JOB-List > see 11.1 chapter).
- Select operating and welding type
- Adjust welding power
- Correct arc length and dynamics if necessary
- Adjust expert parameters for special applications

5.2.6.1 Basic welding parameters

The user must first determine the basic parameters (material type, wire diameter and shielding gas type) of the welding system. These basic parameters are then compared with the welding job list (JOB-LIST). The combination of the basic parameters gives a JOB number, which must now be entered on the control unit. This basic setting must be rechecked or adjusted only when changing the wire or gas.

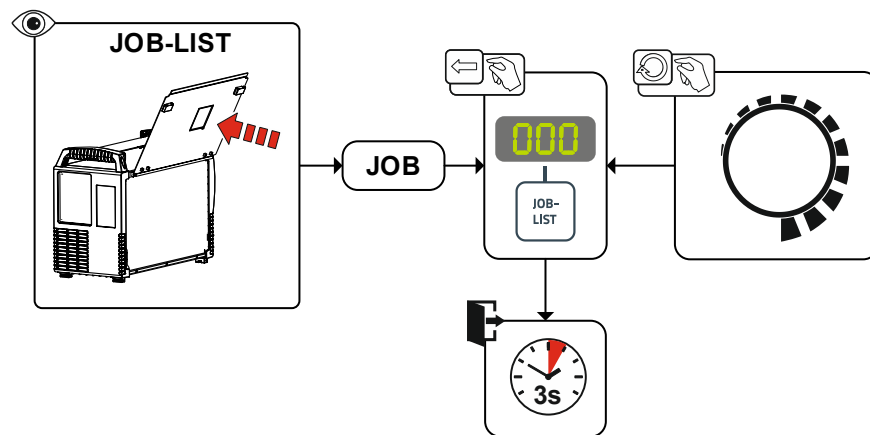

Figure 5-19

The settings for spot time, pause time and wire feed speed apply to all JOBS. All other parameter values are stored separately in each JOB. Changes are permanently saved in the currently selected JOB.

If required, these parameter values can be reset to the factory settings > see 7.5 chapter.

5.2.6.2 Operating mode

The operating mode determines the process sequence controlled by the welding torch. Detailed descriptions of the operating modes > see 5.2.11 chapter.

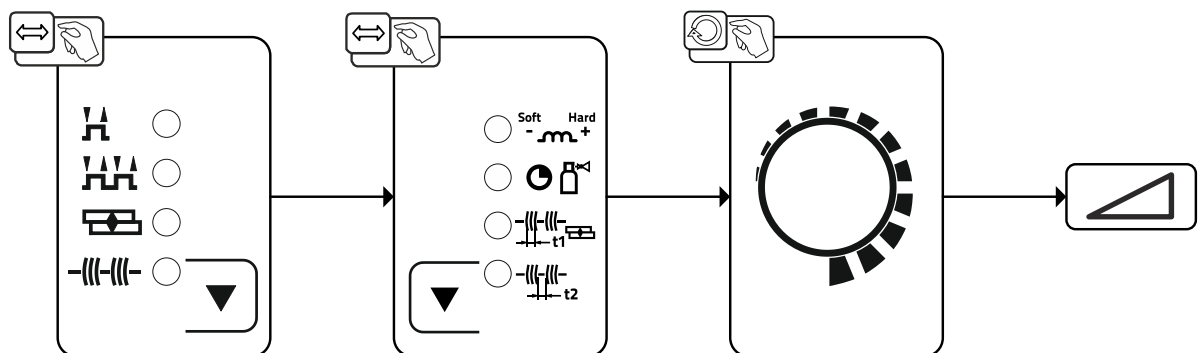

Figure 5-20

5.2.7 Welding power (operating point)

5.2.7.1 Selecting the welding parameter display mode

The operating point (welding power) can be displayed or set as the welding current, material thickness or wire speed.

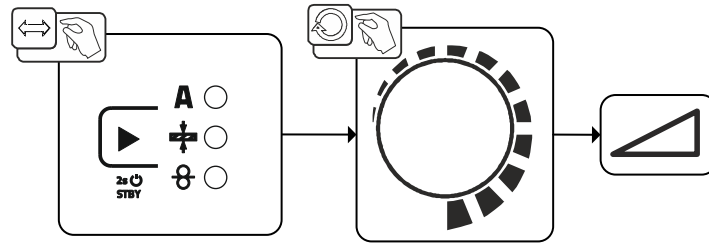

Figure 5-21

5.2.7.2 Arc length

If required, the arc length (welding voltage) can be corrected from -5 V to +5 V for the individual welding task.

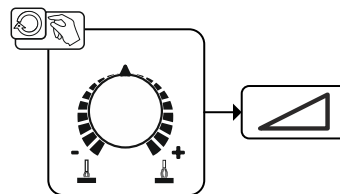

Figure 5-22

The basic settings are now completed. Other welding parameters have already been set optimally in the factory; they can, however, be modified to suit individual requirements.

5.2.7.3 Arc dynamics (choke effect)

This function can be used to adjust the arc between a narrow, hard arc with deep penetration (positive values) and a wide and soft arc (negative values).

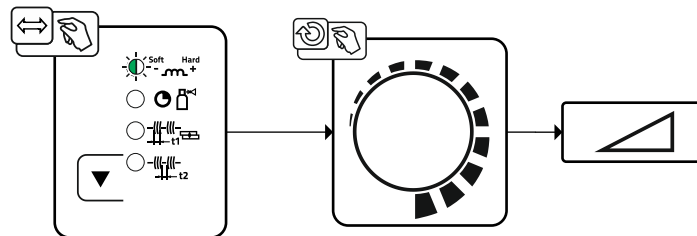

Figure 5-23

5.2.8 Conventional MIG/MAG Welding (GMAW non synergic)

You can only change the JOB number when no welding current is flowing.

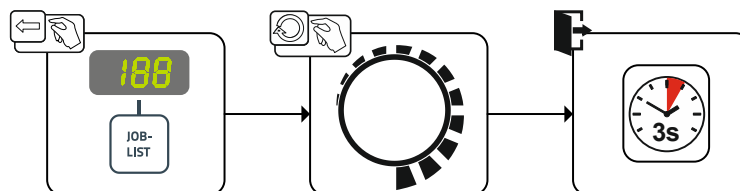

Figure 5-24

5.2.9 forceArc

Heat-reduced, directionally-stable and powerful arc with deep fusion penetration for the upper power range.

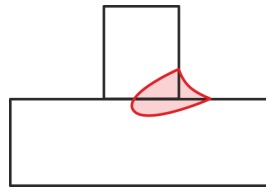

Figure 5-25

- Smaller included angle due to deep penetration and directionally stable arc
- Excellent root and sidewall fusion
- Secure welding also with very long stick-outs
- Reduced undercuts
- Manual and automated applications

You can make use of these properties after selecting the forceArc process > see 5.2.6 chapter.

As with pulse arc welding, it is important to make sure of a good welding current connection.

- Keep welding current cables as short as possible and ensure that cable cross-sections are adequate!
- Fully unroll welding current cables, torch hose packages and, if applicable, intermediate hose packages. Avoid loops!
- Use welding torches, preferably water-cooled, that are suitable for the higher power range.
- Use welding wire with adequate copper coating when welding steel. The wire spool should have layer spooling.

Unstable arc!

Welding current cables that are not fully unrolled can cause faults in the arc (flickering).

- **Fully unroll welding current cables, torch hose packages and, if applicable, intermediate hose packages. Avoid loops!**

5.2.10 rootArc

Short arc with perfect weld modelling capabilities for effortless gap bridging, especially for root welding



Figure 5-26

- Reduced spatter compared to standard short arc
- Good root formation and secure sidewall fusion
- Manual and automated applications











Unstable arc!

Welding current cables that are not fully unrolled can cause faults in the arc (flickering).

- **Fully unroll welding current cables, torch hose packages and, if applicable, intermediate hose packages. Avoid loops!**

5.2.11 Operating modes (functional sequences)

5.2.11.1 Explanation of signs and functions

Symbol	Meaning
	Press torch trigger
	Release torch trigger
	Shielding gas flowing
	Welding output
	Wire electrode is being conveyed
	Wire creep
	Wire burn-back
	Gas pre-flows
	Gas post-flows
	Non-latched
	Latched
t	Time
t₁	Spot time
t₂	Pause time

5.2.11.2 Automatic cut-out

Once the fault periods have elapsed, the automatic cut-out stops the welding process when it has been triggered by one of two states:

- During ignition
5 s after the start of the welding process, no welding current flows (ignition error).
- During welding
The arc is interrupted for more than 5 s (arc interruption).

Non-latched mode

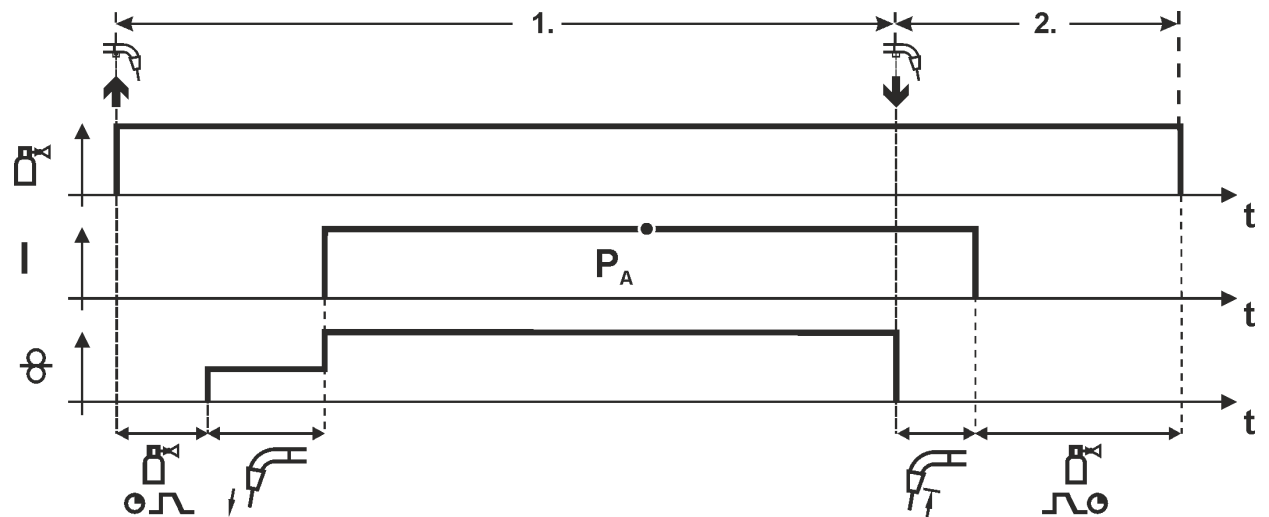

Figure 5-27

Step 1

- Press and hold torch trigger.
- Shielding gas is expelled (gas pre-flows).
- Wire feed motor runs at "creep speed".
- Arc ignites after the wire electrode makes contact with the workpiece; welding current flows.
- Change over to pre-selected wire speed.

Step 2

- Release torch trigger.
- WF motor stops.
- Arc is extinguished after the preselected wire burn-back time expires.
- Gas post-flow time elapses.

Special, non-latched

The activation or setting of this operating mode is described in the chapter Program sequence > see 5.2.12 chapter.

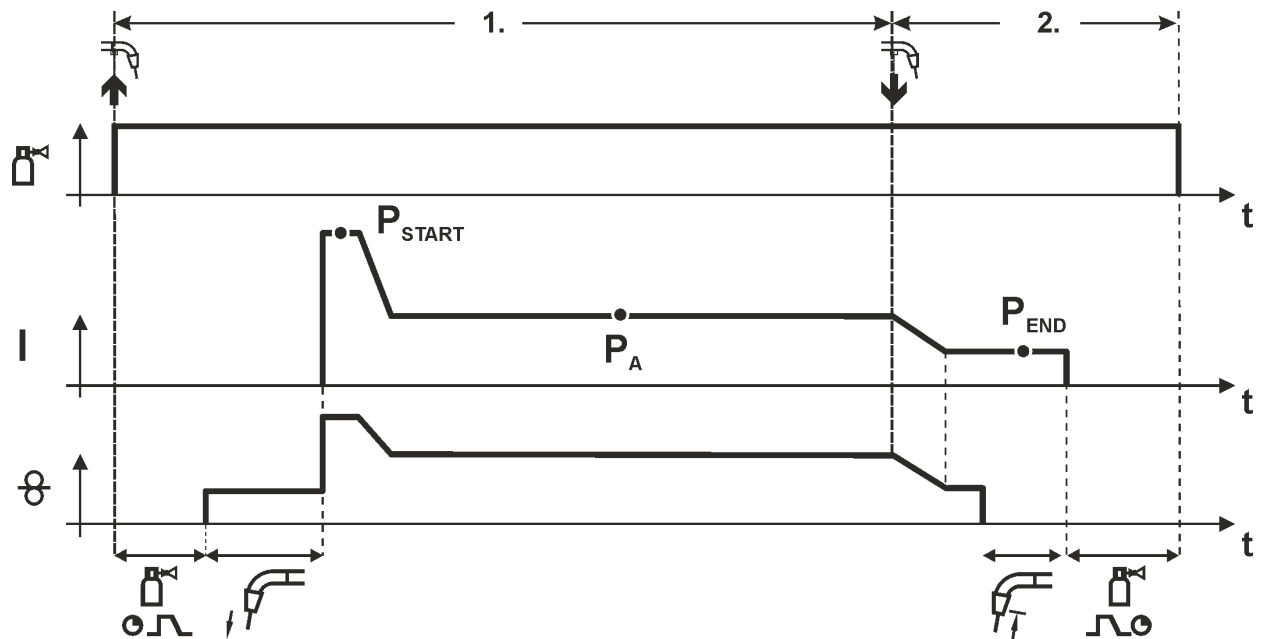

Figure 5-28

Step 1

- Press and hold torch trigger
- Shielding gas is expelled (gas pre-flows)
- Wire feed motor runs at “creep speed”.
- Arc ignites after the wire electrode makes contact with the workpiece, welding current is flowing (start program P_{START} for the time t_{start})
- Slope to main program P_A .

Step 2

- Release torch trigger
- Slope to end program P_{END} for the time t_{end} .
- WF motor stops.
- Arc is extinguished after the preselected wire burn-back time expires.
- Gas post-flow time elapses.

Latched mode

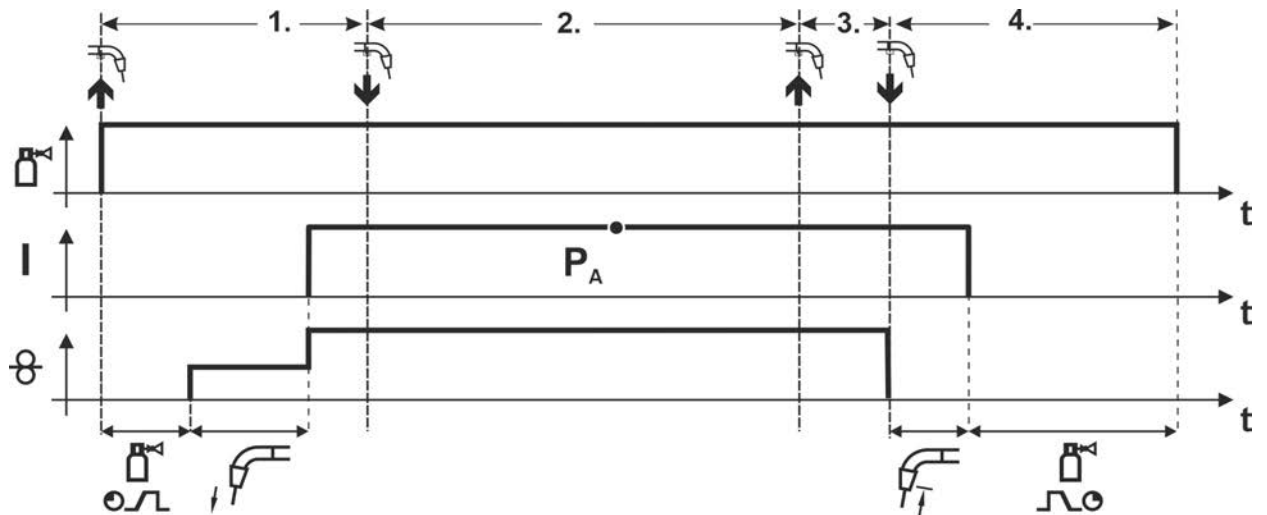

Figure 5-29

1. cycle

- Press and hold torch trigger
- Shielding gas is expelled (gas pre-flows)
- Wire feed motor runs at “creep speed”
- Arc ignites when the wire electrode makes contact with the workpiece
Welding current flows
- Wire feed speed increases to the set nominal value

2. cycle

- Release torch trigger (no effect)

3. cycle

- Press torch trigger (no effect)

4. cycle

- Release torch trigger
- Wire feed motor stops
- Arc is extinguished after the pre-selected wire burn-back time elapses
- Gas post-flow time elapses

Latched special

The activation or setting of this operating mode is described in the chapter Program sequence > see 5.2.12 chapter.

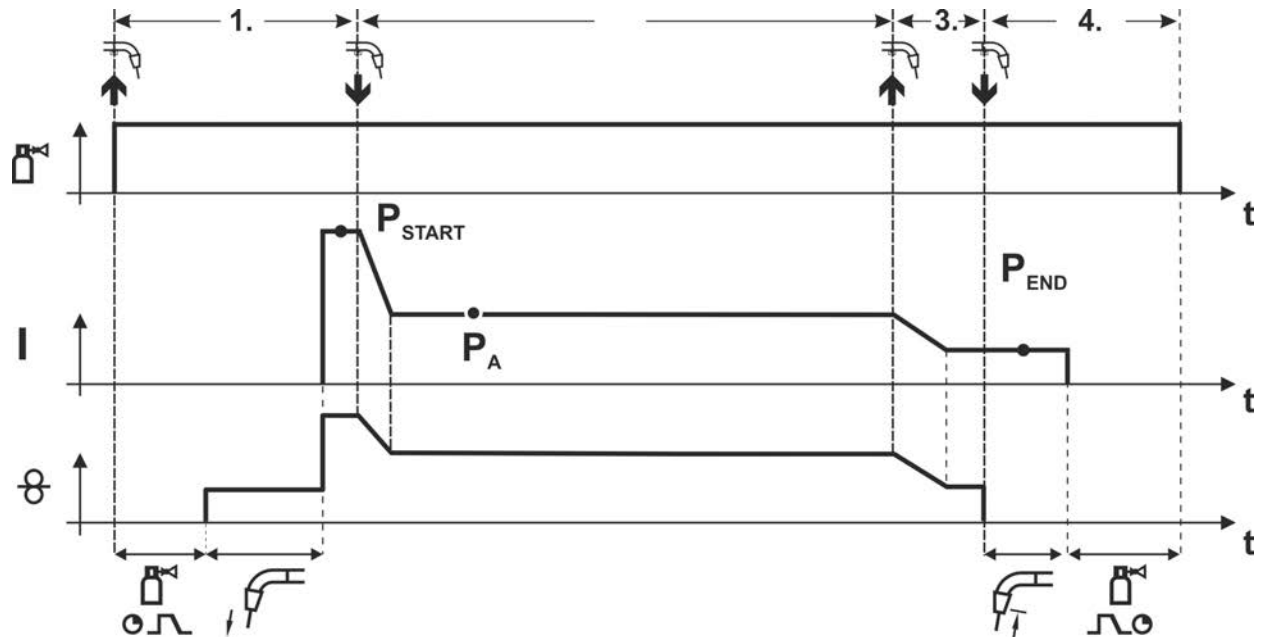

Figure 5-30

1st cycle

- Press and hold torch trigger.
- Shielding gas is flowing (gas pre-flow).
- Wire feed motor runs at “wire creep speed”.
- Arc ignites when the wire electrode makes contact with the workpiece, welding current is flowing (start program P_{START}).

2nd cycle

- Release torch trigger.
- Slope to main program P_A .

3rd cycle

- Press and hold torch trigger.
- Slope to end program P_{END} .

4th cycle

- Release torch trigger.
- Wire feed motor stops.
- The arc is extinguished once the wire burn-back time has elapsed.
- Gas post-flow time elapses.

Spot welding

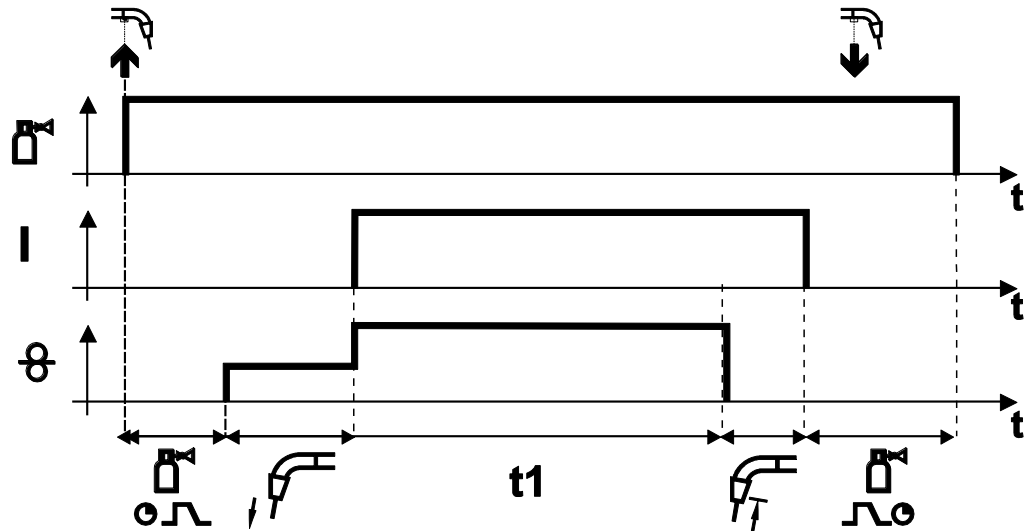

Figure 5-31

Start

- Press and hold torch trigger.
- Shielding gas is expelled (gas pre-flows).
- Arc ignites after the wire electrode makes contact with the workpiece at creep speed.
- Welding current flows.
- Wire feed speed increases to the set nominal value.
- The wire feed stop welding after the spot time elapses.
- Arc is extinguished after the wire burn-back time elapses.
- Gas post-flow time elapses.

Premature termination

- Release torch trigger.

Interval

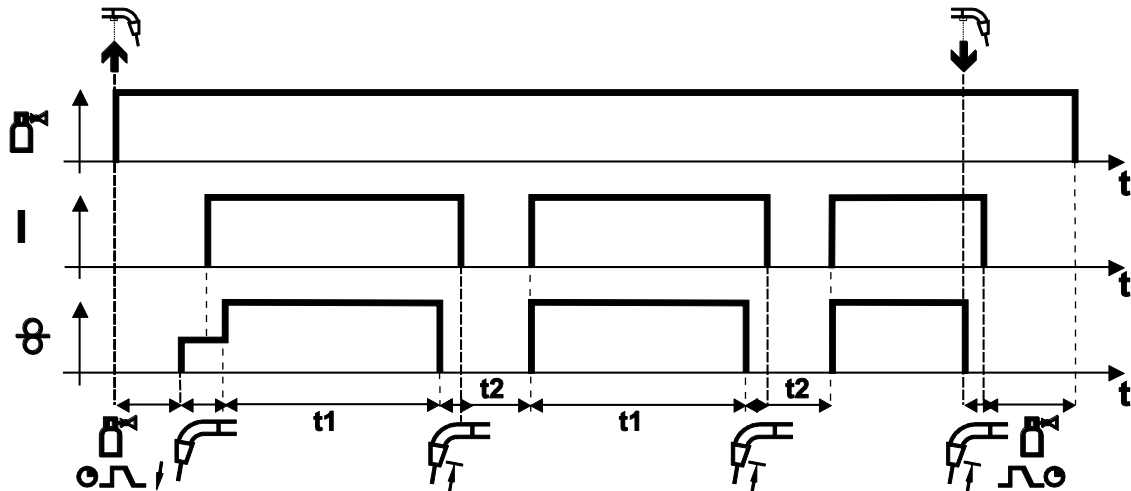

Figure 5-32

Start

- Press and hold torch trigger.
- Shielding gas is expelled (gas pre-flows).

Sequence

- Arc ignites after the wire electrode makes contact with the workpiece at creep speed.
- Welding current flows.
- Wire feed speed increases to the set nominal value.
- The wire feed stops after the spot time elapses.
- Arc is extinguished after the wire burn-back time elapses.
- The process is repeated when the pause time is over.

End

- Release torch trigger, wire feed stops, arc is extinguished, gas post-flow time elapses.

If the pause time is less than 3 s, wire creep only takes place in the first spot phase.

When the torch trigger is released, the welding process is also ended even before the spot time elapses.

5.2.12 Program sequence

Certain materials require additional programs for reliable, high-quality welding. In addition to the main program P_A (continuous welding), a start program P_{START} (prevention of cold welds at the start of the seam) and an end program P_{END} (prevention of end-craters through targeted heat reduction) are used.

Depending on the selected welding task (JOB), additional parameters for the start or end program are or will be activated (non-latched or special latched). You can adjust the additional parameters of the start and end program individually in the expert menu > see 5.2.13 chapter. The parameters of the end program become active after selecting the crater fill function on the control.

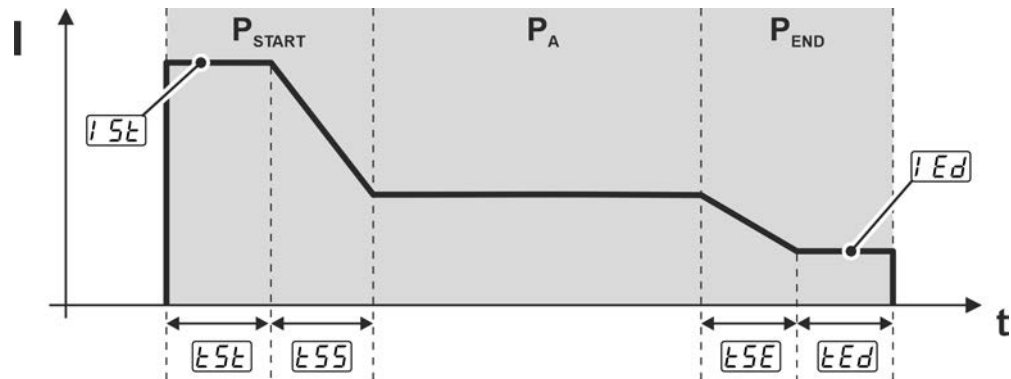

Figure 5-33

Display	Setting/selection
P_{START}	Start program
P_A	Main program
P_{END}	End program
$1.5I$	Start current as percentage - dependent on main current
$t5t$	Start time - duration of start current
$t55$	Slope time of start program P_{START} to main program P_A
$t5E$	Slope time of main program P_A to end program P_{END}
$1Ed$	End current as a percentage - dependent on main current
tEd	End current time - duration of end current

5.2.13 Expert menu (MIG/MAG)

The Expert menu has adjustable parameters stored that don't require regular setting. The number of parameters shown may be limited, e.g. if a function is deactivated.

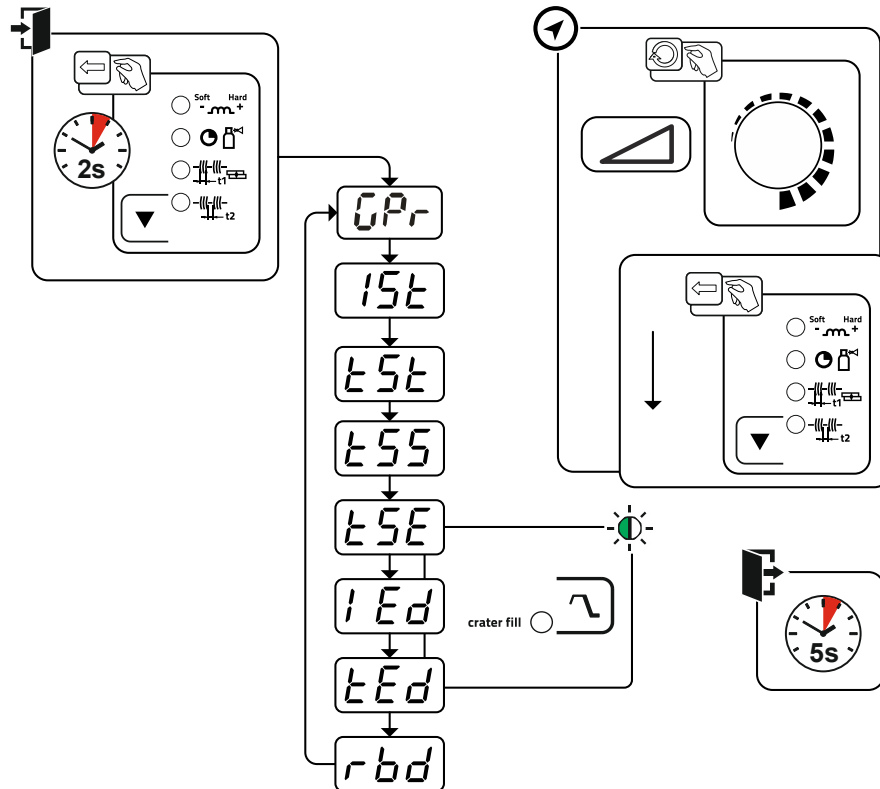

Figure 5-34

Display	Setting/selection
GPr	Gas pre-flow time
15t	Start current as percentage - dependent on main current
t5t	Start time - duration of start current
t55	Slope time of start program P _{START} to main program P _A
t5E	Slope time of main program P _A to end program P _{END}
1Ed	End current as a percentage - dependent on main current
tEd	End current time - duration of end current
rbd	Burn-back correction

5.3 MMA welding

5.3.1 Connecting the electrode holder and workpiece lead

⚠ CAUTION



Risk of crushing and burns!

When changing stick electrodes there is a risk of crushing and burns!

- Wear appropriate and dry protective gloves.
- Use an insulated pair of tongs to remove the used stick electrode or to move welded workpieces.

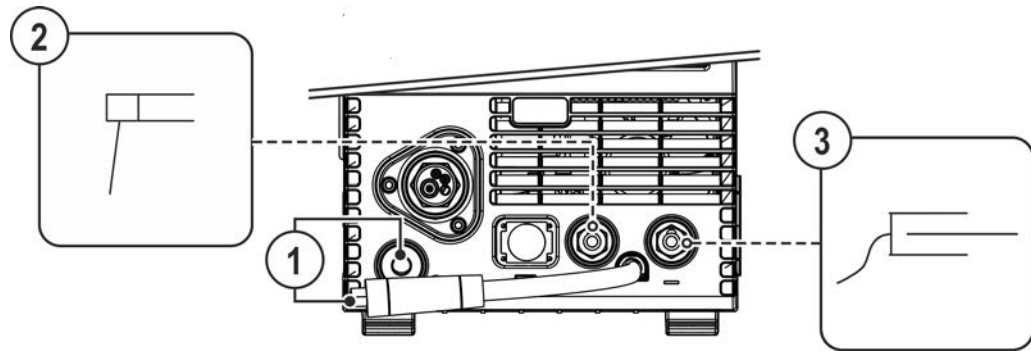

Figure 5-35

Item	Symbol	Description
1		Polarity selector plug welding current cable <ul style="list-style-type: none"> • Connect to the park socket.
2		Electrode holder
3		Workpiece

- Insert the polarity selection plug in the park socket and lock in place by turning to the right.
- Insert the electrode holder plug and workpiece lead into the welding current socket depending on application and lock in place by turning to the right. The corresponding polarity will be based on the information of the electrode manufacturer on the electrode packaging.

5.3.2 Welding task selection

- Select MMA JOB 128 > see 11.1 chapter.

You can only change the JOB number when no welding current is flowing.

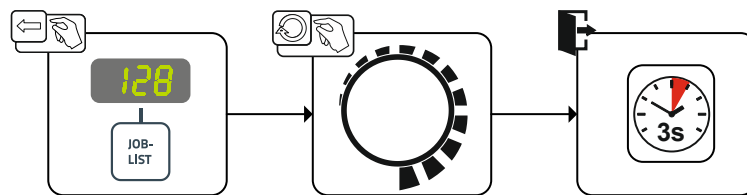

Figure 5-36

5.3.3 Arcforce

During the welding process, arcforce prevents the electrode sticking in the weld pool with increases in current. This makes it easier to weld large-drop melting electrode types at low current strengths with a short arc in particular.

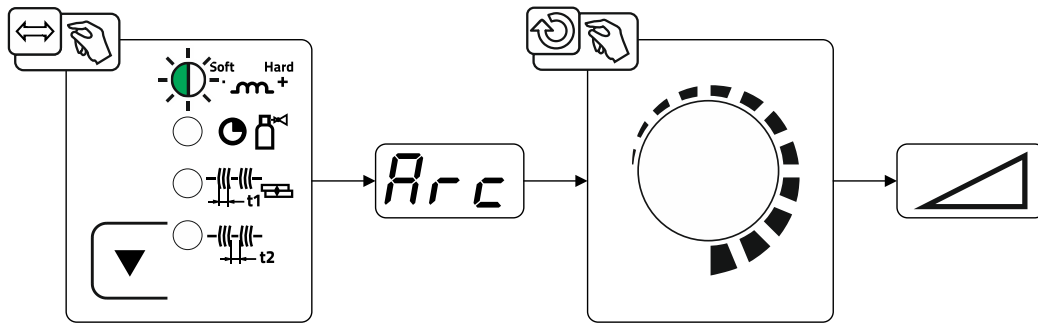

Figure 5-37

Display	Setting/selection
	Arcforce correction <ul style="list-style-type: none"> • Increase value > harder arc • Decrease value > softer arc

5.3.4 Hotstart

The function hot start ensures a secure igniting of the arc and a sufficient heating to the still cold parent metal at the beginning of the welding process. The ignition takes place here with increased current (hot start current) over a certain time (hot start time).

For parameter setting, > see 5.3.6 chapter.

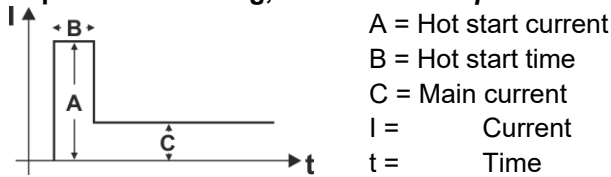
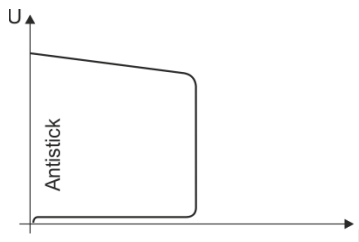

Figure 5-38

5.3.5 Antistick



The Antistick feature prevents the electrode from annealing.

Should the electrode stick despite the Arcforce feature, the machine automatically switches to the minimum current within approx. one second. This prevents the electrode from annealing. Check the welding current setting and correct for the welding task in hand.

Figure 5-39

5.3.6 Expert menu (MMA)

The Expert menu has adjustable parameters stored that don't require regular setting. The number of parameters shown may be limited, e.g. if a function is deactivated.

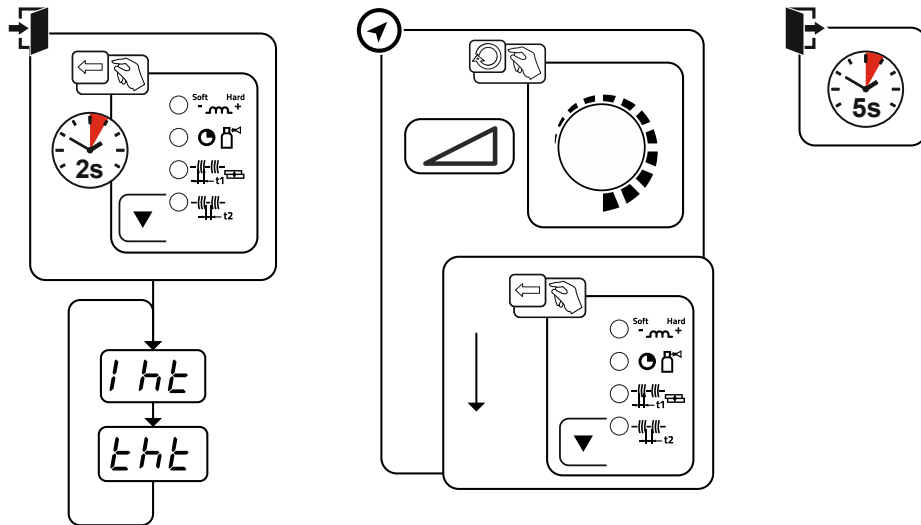

Figure 5-40

Display	Setting/selection
	Hotstart current
	Hotstart time

5.4 TIG welding

5.4.1 Preparing the TIG welding torch

The TIG welding torch is to be equipped to suit the relevant welding task!

- Fit suitable tungsten electrodes and
- an appropriate shielding gas nozzle.
- Observe the operating instructions for the TIG welding torch!

5.4.2 Welding torch and workpiece line connection

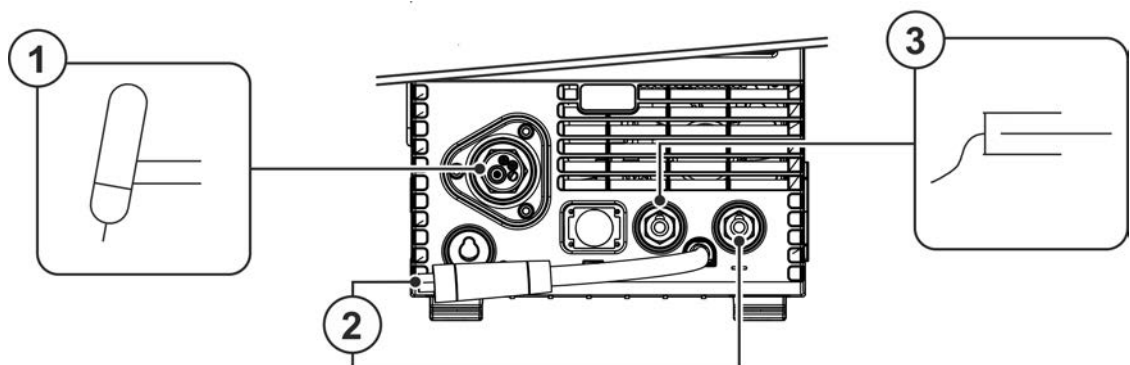

Figure 5-41

Item	Symbol	Description
1		Welding torch
2		Polarity selector plug welding current cable Internal welding current cable for central connection/welding torch. • Connection socket for (-) welding current
3		Workpiece

- Insert the central plug for the welding torch into the central connector and screw together with crown nut.
- Insert the polarity selection plug into the "-" welding current connection socket and lock in place by turning to the right.
- Insert the plug of the workpiece lead into the "+" welding current connection socket and lock in place by turning to the right.

5.4.3 Welding task selection

- Select TIG JOB 127.

You can only change the JOB number when no welding current is flowing.

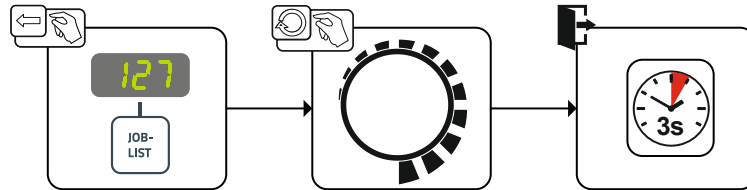

Figure 5-42

5.4.4 Adjusting the gas post-flow time

- Preselection: Select TIG JOB 127 > see 5.4.3 chapter.

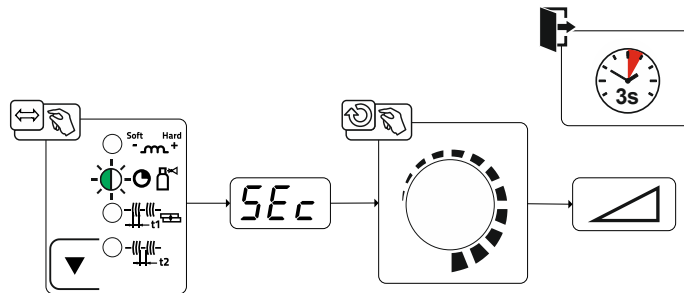

Figure 5-43

Display	Setting/selection
5Ec	Gas post-flow time

5.4.5 Expert menu (TIG)

The Expert menu has adjustable parameters stored that don't require regular setting. The number of parameters shown may be limited, e.g. if a function is deactivated.

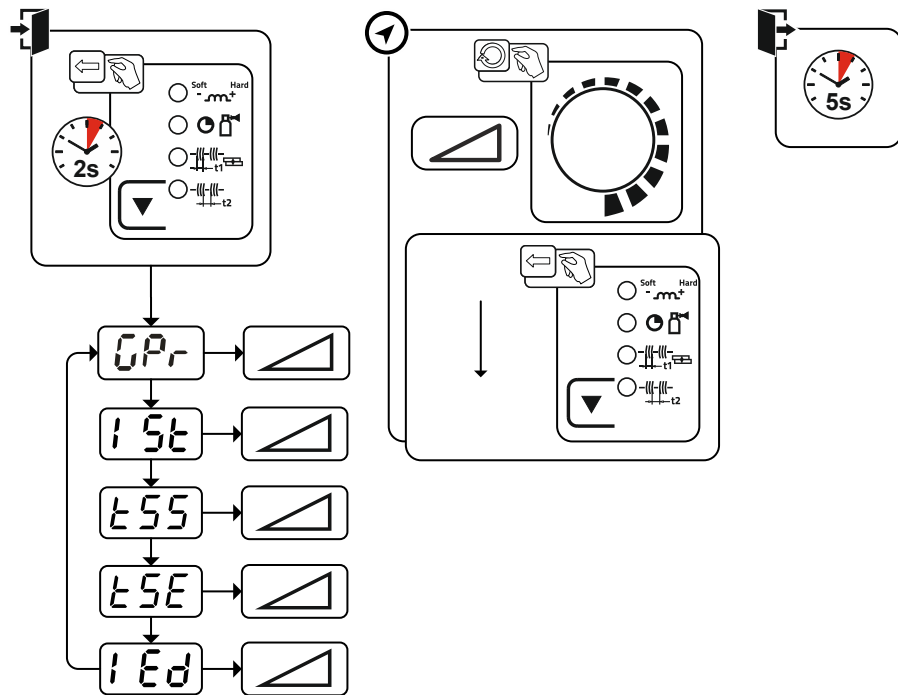

Figure 5-44

Display	Setting/selection
GPr	Gas pre-flow time
1St	Start current as percentage - dependent on main current
t55	Slope time from start current to main current.
t5E	Slope time from main current to end current.
1Ed	End current as a percentage - dependent on main current

5.4.6 Arc ignition

5.4.6.1 Liftarc

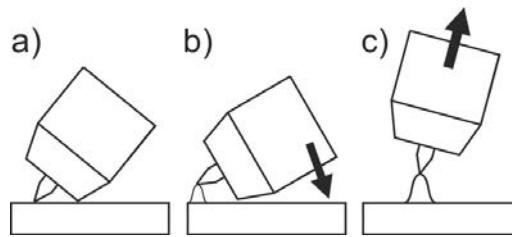

Figure 5-45

The arc ignites through contact with the workpiece:

- Carefully place the torch gas nozzle and tungsten electrode tip against the workpiece (lift arc current flows independent of the set main current)
- Angle the torch above the torch gas nozzle until the distance between electrode tip and workpiece is approx. 2–3 mm (arc ignites, current increases to the set main current).
- Lift the torch off and bring into normal position.

Complete the welding task: Remove the torch from the workpiece so that the arc extinguishes.

5.4.7 Operating modes (functional sequences)

5.4.7.1 Explanation of symbols

Symbol	Meaning
	Press and hold the torch trigger
	Release the torch trigger
I	Current
	Non-latched
	Latched
t	Time
	Gas pre-flow
	Start current
	Start time
	Slope time from start current to main current
	Main current AMP
	Slope time from main current to end current
	End current
	End current time
	Gas post-flow

5.4.7.2 Automatic cut-out

Once the fault periods have elapsed, the automatic cut-out stops the welding process when it has been triggered by one of two states:

- During ignition
5 s after the start of the welding process, no welding current flows (ignition error).
- During welding
The arc is interrupted for more than 5 s (arc interruption).

5.4.7.3 Non-latched mode Sequence

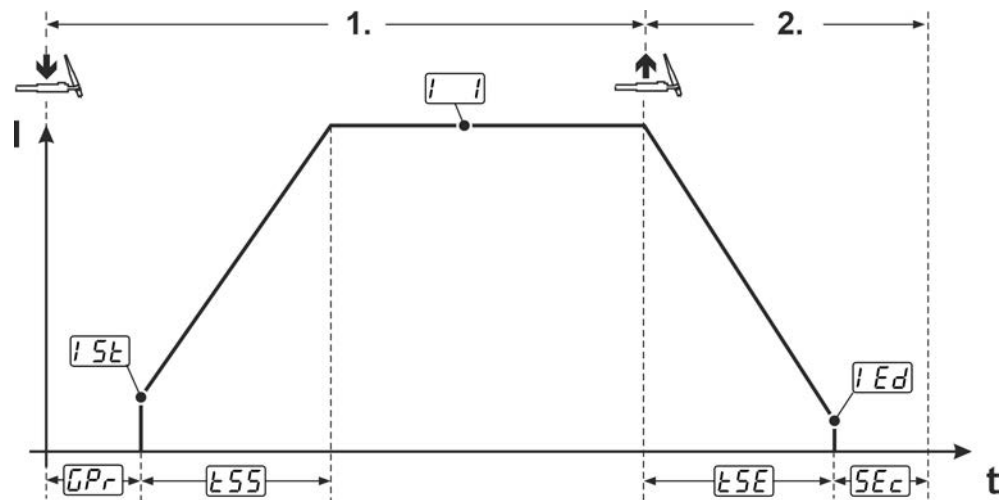

Figure 5-46

1st cycle:

- Press and hold torch trigger 1.
- The gas pre-flow time \overline{GPr} expires (shielding gas flows).
- The arc striking takes place on contact with the workpiece (lift arc) > see 5.4.6 chapter.
- The start current \overline{ISt} flows.
- The welding current increases in the up-slope time \overline{ESU} to the main current \overline{I} .

2nd cycle:

- Release torch trigger 1.
- The main current \overline{I} drops during the down-slope time \overline{ESE} to the end current \overline{IEd} . The arc extinguishes.
- When the 1st torch trigger is pressed during the down-slope time \overline{ESE} , the current increases again to the main current \overline{I} .
- The gas post-flow time \overline{SEc} expires (the shielding gas is shut down).

5.4.7.4 Latched mode

Sequence

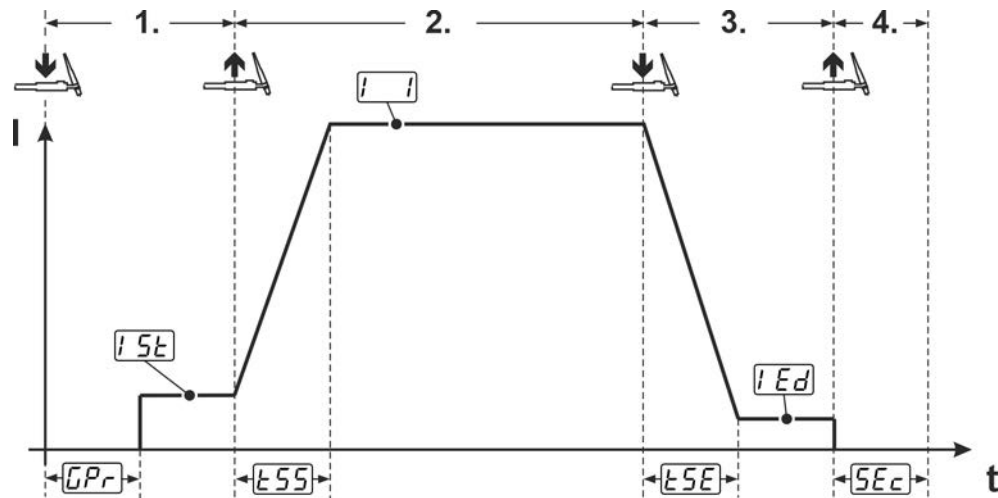

Figure 5-47

1st cycle

- Press the torch trigger 1.
- The gas pre-flow time t_{PR} expires (shielding gas flows).
- The arc striking takes place on contact with the workpiece (lift arc) > see 5.4.6 chapter.
- The start current I_{St} flows.

2nd cycle

- Release torch trigger 1.
- The welding current increases in the slope time t_{SS} to the main current I .

3rd cycle

- Press torch trigger 1.
- The main current I drops during the slope time t_{SE} to the end current I_{Ed} .

Releasing the torch trigger during the slope time t_{SE} ends the welding process immediately.

4th cycle

- Release torch trigger 1.
- The arc extinguishes.
- The gas post-flow time t_{EC} expires (the shielding gas is shut down).

5.5 Remote control

Remote controls are used for the remote operation of various machine functions.

The remote controls are operated on the 19-pole remote control connection socket (analogue).

5.6 Special parameters (advanced settings)

Special parameters (P1 to Pn) are applied for customer-specific configuration of machine functions. This allows the user maximum flexibility in optimising their requirements.

These settings are not configured directly on the machine control since a regular setting of the parameters is generally not required. The number of selectable special parameters can deviate between the machine controls used in the welding system (also see the relevant standard operating instructions).

If required, the special parameters can be reset to the factory settings > see 5.6.3 chapter.

5.6.1 Selecting, changing and saving parameters

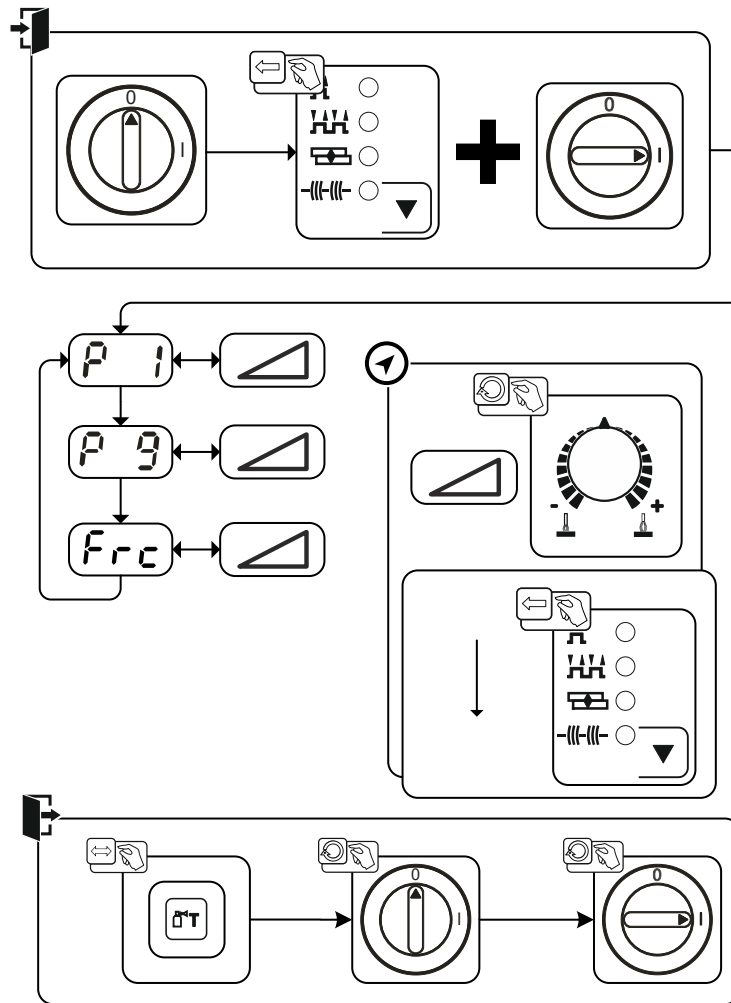

Figure 5-48

Display	Setting/selection
	Wire inching / wire return ramp time 0 = ----- normal inching (10 s ramp time) 1 = ----- fast inching (3 s ramp time) (ex works)
	Lat. and sp. lat. tapping start 0 = ----- no latched tapping start (Ex works) 1 = ----- latched tapping start possible
	Remote control encoding (Frc) 0----- Automatic remote control detection (ex works) 2----- Remote control encoding for accessory components with a single rotary knob only 9----- Remote control encoding for accessory components with a single pair of buttons or a rocker only 1, 3-8 --- No remote control encoding 10-15 --- No remote control encoding

5.6.2 Special parameters in detail

5.6.2.1 Ramp time for wire inching (P1)

The wire inching starts with a speed 1.0 m/min for 2 secs. It is subsequently increased to a ramp function to 6.0 m/min. The ramp time can be set between two ranges.

During wire inching, the speed can be changed by means of the welding power rotary knob. Changing the speed has no effect on the ramp time.

5.6.2.2 Latched/special-latched tap start (P9)

In latched – tap start – operating mode it is possible to switch straight to the second step by tapping the torch trigger; it is not necessary for current to be flowing.

The welding can be halted by pressing the torch trigger for a second time.

5.6.3 Reset to factory settings

All special parameters saved by the user will be overwritten by the factory settings!

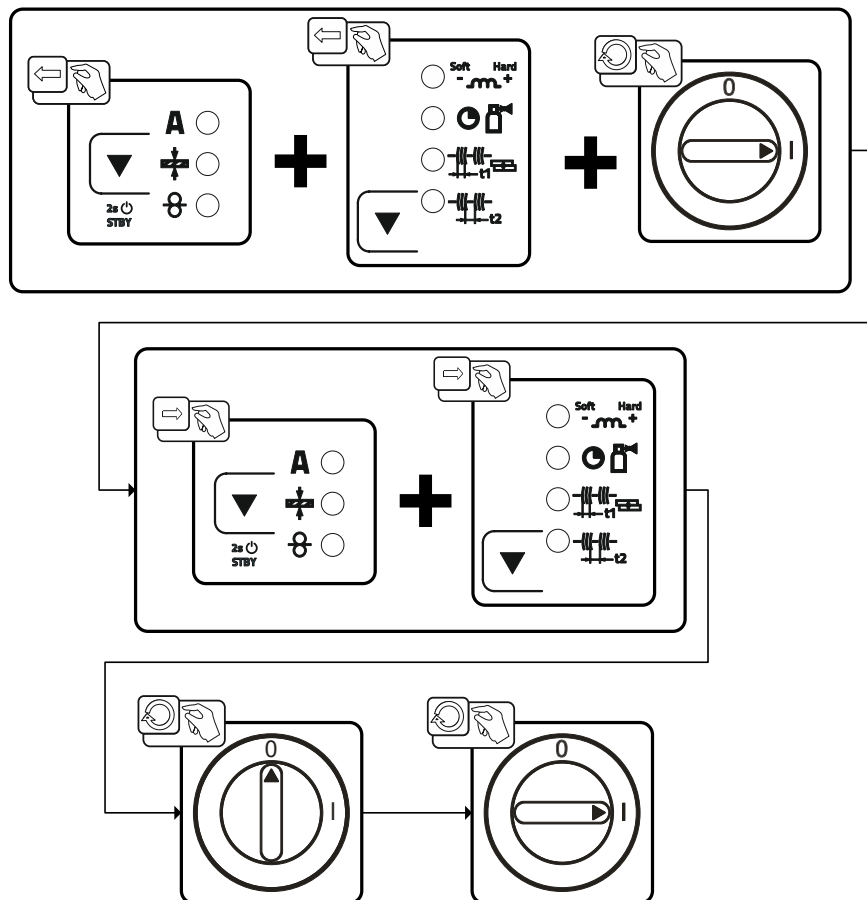

Figure 5-49

5.7 Machine configuration menu

5.7.1 Selecting, changing and saving parameters

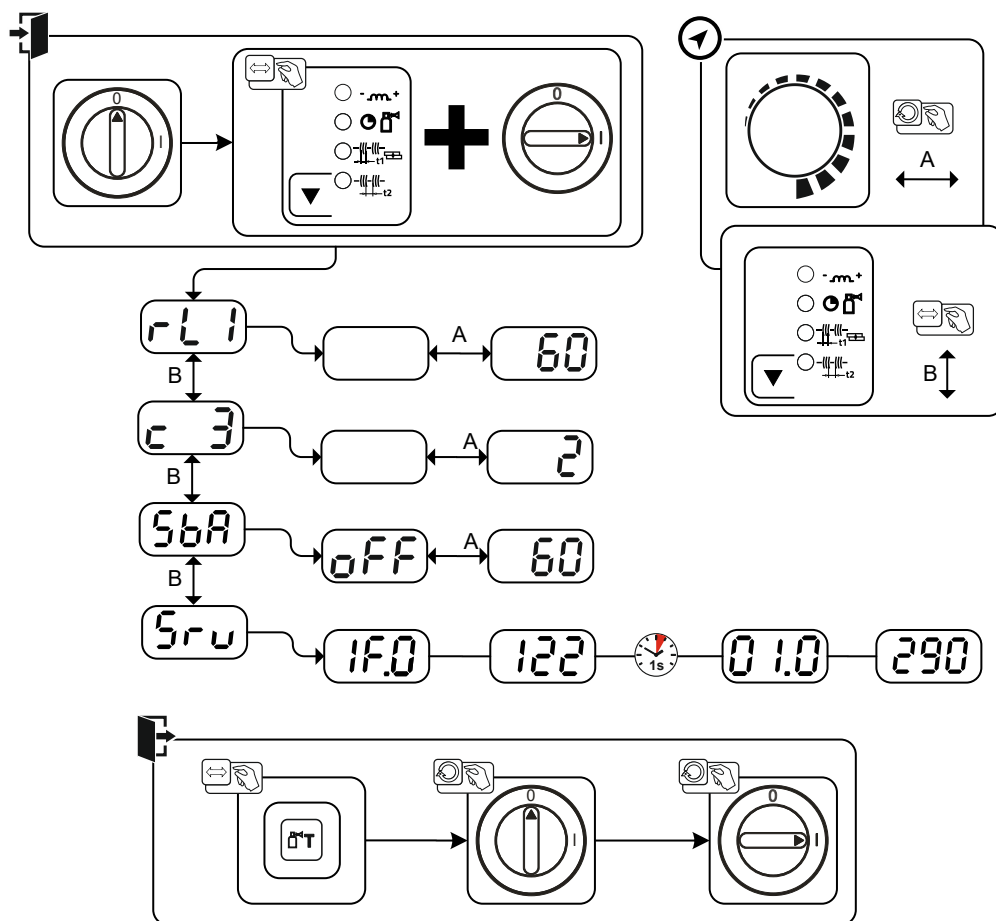

Figure 5-50

Display	Setting/selection
rL 1	Lead resistance 1 Lead resistance for the first welding circuit 0 mΩ–60 mΩ (8 mΩ ex works).
c 3	Only qualified service personnel may change the parameters!
5bA	Time-based power-saving mode > see 5.7.3 chapter Time to activation of the power-saving mode in case of inactivity. Setting OFF = disabled or numerical value 5-60 min..
5ru	Service menu Any changes to the service menu should be agreed with the authorised service personnel.

5.7.2 Aligning the cable resistance

The resistance value of cables can either be set directly or it can be aligned using the power source. The factory setting of the power sources is 8 mΩ. This value corresponds to a 5 m earth cable, a 1.5 m intermediate hose package and a 3 m water-cooled welding torch. With other hose package lengths, it is necessary to carry out a +/- voltage correction to optimise welding properties. The voltage correction value can be set close to zero by means of realigning the cable resistance. It is recommended to align the electric cable resistance after replacing accessories such as torches or intermediate hose packages.

In case a second wire feeder is used the (rL2) parameter has to be aligned. For all other configurations it is sufficient to align the (rL1) parameter.

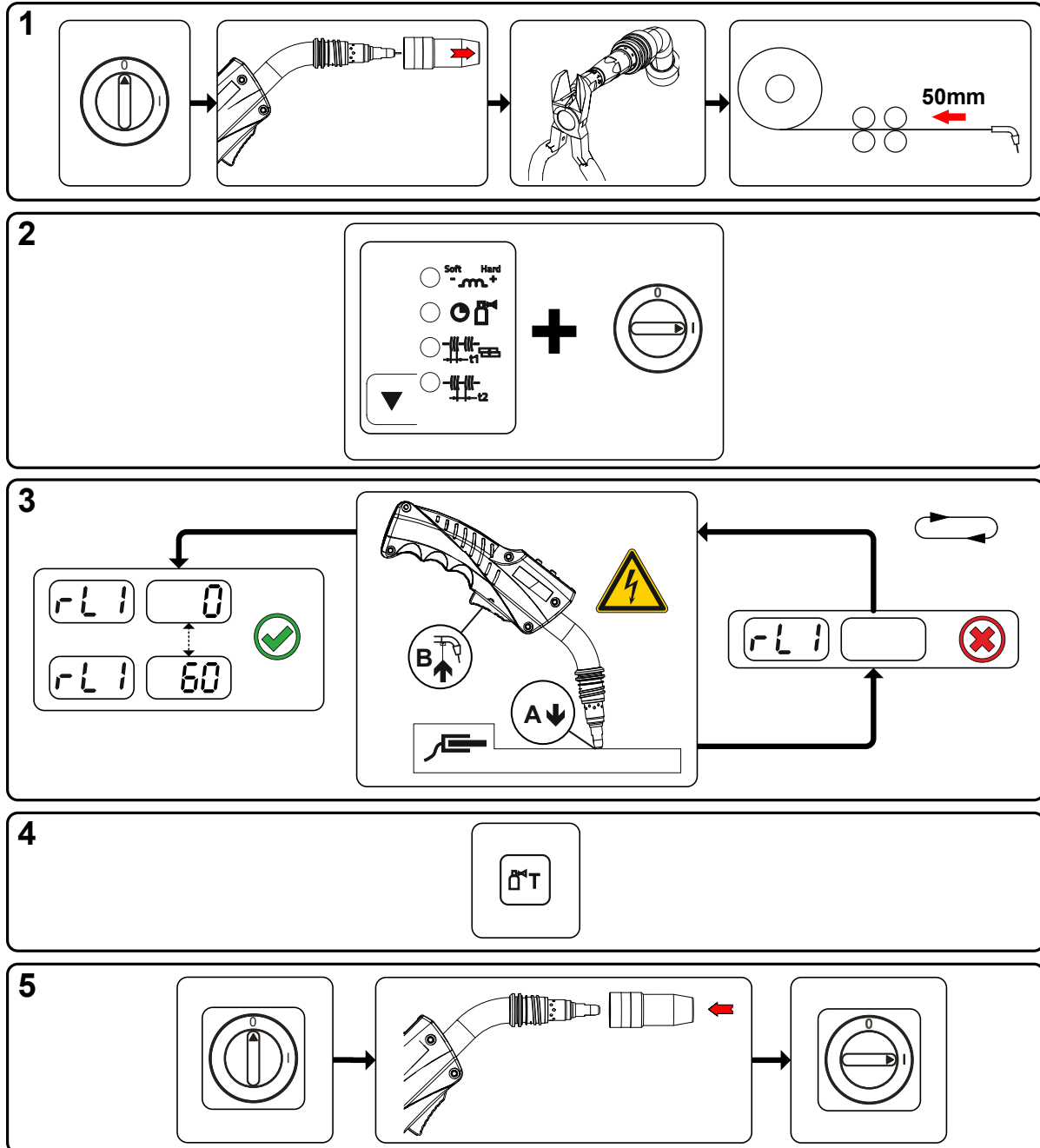

Figure 5-51

1 Preparation

- Switch off the welding machine.
- Unscrew the gas nozzle from the welding torch.
- Trim the welding wire so that it is flush with the contact tip.
- Retract the welding wire a little (approx. 50 mm) on the wire feeder. There should now be no more welding wire in the contact tip.

2 Configuration

- Press the "sequence parameter" push-button while simultaneously switching on the welding machine. Release the "sequence parameter" push-button.
- The desired parameter can now be selected using the "sequence parameter" push-button. Parameter rL1 must be adjusted for all machine combinations. In case of welding systems with a second power circuit – if two wire feeders are to be operated from a single power source, for example – a second adjustment with parameter rL2 must be performed.

3 Alignment/Measurement

- Applying slight pressure, put the welding torch in place with the contact tip on a clean, purged location on the workpiece and then press the torch trigger for approx. 2 seconds. A short-circuit current will flow briefly, which is used to determine and display the new cable resistance. The value can be between 0 mΩ and 40 mΩ. The new value is immediately saved without requiring further confirmation. If no value is shown on the right-hand display, then measurement failed. The measurement must be repeated.

4 Saving

- Press the "gas test" push-button.

5 Restoring welding standby mode

- Switch off the welding machine.
- Screw the gas nozzle onto the welding torch.
- Switch on the welding machine.
- Insert the welding wire.

5.7.3 Power-saving mode (Standby)

You can activate the power-saving mode by either pressing the push-button > see 4.3 chapter for a prolonged time or by setting a parameter in the machine configuration menu (time-controlled power-saving mode ) > see 5.7 chapter.

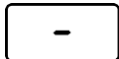

When power-saving mode is activated, the machine displays show the horizontal digit in the centre of the display only.

Pressing any operating element (e.g. turning a rotary knob) deactivates power-saving mode and the machine is ready for welding again.

6 Maintenance, care and disposal

6.1 General

⚠ DANGER

Risk of injury due to electrical voltage after switching off!
Working on an open machine can lead to fatal injuries!
Capacitors are loaded with electrical voltage during operation. Voltage remains present for up to four minutes after the mains plug is removed.

1. Switch off machine.
2. Remove the mains plug.
3. Wait for at last 4 minutes until the capacitors have discharged!

⚠ WARNING

Improper maintenance, testing and repairs!
Maintenance, testing and repair of the machine may only be carried out by skilled and qualified personnel (authorised service personnel). A competent person is someone who, based on training, knowledge and experience, can recognize the hazards and possible consequential damage that may occur when testing power sources and can take the necessary safety precautions.

- Follow the maintenance instructions > see 6.3 chapter.
- If any of the test requirements below are not met, the unit must not be put back into operation until it has been repaired and tested again.

Repair and maintenance work may only be performed by qualified authorised personnel; otherwise the right to claim under warranty is void. In all service matters, always consult the dealer who supplied the machine. Return deliveries of defective equipment subject to warranty may only be made through your dealer. When replacing parts, use only original spare parts. When ordering spare parts, please quote the machine type, serial number and item number of the machine, as well as the type designation and item number of the spare part.

Under the specified ambient conditions and normal working conditions this machine is essentially maintenance-free and requires just a minimum of care.

Contamination of the machine may impair service life and duty cycle. The cleaning intervals depend on the ambient conditions and the resulting contamination of the machine. The minimum interval is every six months.

6.2 Explanation of icons

Personnel

	Welder / operator		Qualified person (authorised service personnel)
--	-------------------	--	---

Test

	Visual inspection		Functional test
--	-------------------	--	-----------------

Period, interval

	One-shift operation		Multi-shift operation
	Every 8 hours		Daily
	Weekly		Monthly
	Every 6 months		Annually

6.3 Maintenance schedule

Inspector	Type of inspection	8h	24h	Maintenance step	Repairer
				<p>! Only personnel designated as inspectors or repairers due to their training are allowed to carry out the relevant work step! Non-applicable inspection points are omitted.</p>	
				<ul style="list-style-type: none"> Check and clean the welding torch. Deposits in the welding torch may cause short circuits, impair the welding result and lead to welding torch damage! Check wire drive, welding torches, and liner elements for application-related equipment and setting. Clean the wire feed rolls on a regular basis (depending on the degree of soiling). Replace worn wire feed rolls. Connections of the welding current leads (check for tight and locked seating). Is shielding gas cylinder with gas cylinder securing elements (chain/belt) secured? Strain relief: Are hose packages secured with strain relief? 	
				<ul style="list-style-type: none"> Checking all supply lines and their connections (pipes, hoses, hose packages) for damage or leaks. Checking the welding system for damage to the housing. Transport elements (strap, lifting eyes, handle, wheels, parking brake) corresponding safety elements (if necessary fuse caps) are present and flawless? 	
				<ul style="list-style-type: none"> Cleaning connections of coolant pipes (quick connect coupling, connections) from impurities and install protective caps when not in use. Gas test that the solenoid valve opens and closes properly. Checking operating, signalling and indicator lights, protective devices and actuators. 	
				<ul style="list-style-type: none"> Check wire feed roll holder (wire feed rolls must be firmly seated on their holders and must not have any play) Cleaning dirt filter (if applicable) 	
				<ul style="list-style-type: none"> Checking correct mounting of the wire spool. 	
				<ul style="list-style-type: none"> Clean external surfaces with a damp cloth (do not use aggressive cleaning agents). 	
				<ul style="list-style-type: none"> Cleaning the power source (inverter) 	
				<ul style="list-style-type: none"> Cleaning heat exchanger (torch cooling) 	
				<ul style="list-style-type: none"> Coolant change (torch cooling) 	
				<ul style="list-style-type: none"> Periodic inspection and testing 	
				<ul style="list-style-type: none"> The coolant must be checked using the appropriate frost protection tester TYP 1 (KF) or FSP (blueCool) for sufficient frost protection and replaced if necessary (accessories). 	

6.4 Disposing of equipment



Proper disposal!

The machine contains valuable raw materials, which should be recycled, and electronic components, which must be disposed of.

- Do not dispose of in household waste!
- Observe the local regulations regarding disposal!

In addition to the national or international regulations mentioned below, it is mandatory to follow the respective national laws and regulations on disposal.

- According to European provisions (Directive 2012/19/EU on Waste of Electrical and Electronic Equipment), used electric and electronic equipment may no longer be placed in unsorted municipal waste. It must be collected separately. The symbol depicting a waste container on wheels indicates that the equipment must be collected separately.

This machine has to be disposed of, or recycled, in accordance with the waste separation systems in use.

According to German law (law governing the distribution, taking back and environmentally correct disposal of electrical and electronic equipment (ElektroG)), used machines are to be placed in a collection system separate from unsorted municipal waste. The public waste management utilities (communities) have created collection points at which used equipment from private households can be disposed of free of charge.

The deletion of personal data is the responsibility of the end user.

Lamps, batteries or accumulators must be removed and disposed of separately before disposing of the device. The type of battery or accumulator and its composition is marked on the top (type CR2032 or SR44). The following EWM products may contain batteries or accumulators:

- Welding helmets
Batteries or accumulators are easy to remove from the LED cassette.
- Device controls
Batteries or accumulators are located on the back of these in corresponding sockets on the circuit board and are easy to remove. The controls can be removed using standard tools.

Information on returning used equipment or collections can be obtained from the respective municipal administration office. Devices can also be returned to EWM sales partners across Europe.

Further information on the topic of the disposal of electrical and electronic equipment can be found on our website at: <https://www.ewm-group.com/de/nachhaltigkeit.html>.

7 Rectifying faults

All products are subject to rigorous production checks and final checks. If, despite this, something fails to work at any time, please check the product using the following flowchart. If none of the fault rectification procedures described leads to the correct functioning of the product, please inform your authorised dealer.

7.1 Checklist for rectifying faults

The correct machine equipment for the material and process gas in use is a fundamental requirement for perfect operation!

Legend	Symbol	Description
	↗	Fault/Cause
	✘	Remedy

Functional errors

- ↗ Mains fuse triggers - unsuitable mains fuse
 - ✘ Set up recommended mains fuse > see 8 chapter.
- ↗ Machine does not start up after switching on (device fan and possibly coolant pump have no function).
 - ✘ Connect the control cable of the wire feeder.
- ↗ All machine control signal lights are illuminated after switching on
- ↗ No machine control signal light is illuminated after switching on
- ↗ No welding power
 - ✘ Phase failure > check mains connection (fuses)
- ↗ Machine restarts continuously
- ↗ Wire feeder without function
- ↗ System does not start up
 - ✘ Make control lead connections and check that they are fitted correctly.
- ↗ Loose welding current connections
 - ✘ Tighten power connections on the torch and/or on the workpiece
 - ✘ Properly fasten the contact tip and contact tip holder.

Coolant error/no coolant flowing

- ↗ Insufficient coolant flow
 - ✘ Check coolant level and refill if necessary
- ↗ Air in the coolant circuit
 - ✘ Vent coolant circuit > see 7.7 chapter

Wire feed problems

- ↗ Contact tip blocked
 - ✘ Clean and, if necessary, replace.
- ↗ Setting the spool brake > see 5.2.4.4 chapter
 - ✘ Check settings and correct if necessary
- ↗ Setting pressure units > see 5.2.4.3 chapter
 - ✘ Check settings and correct if necessary
- ↗ Worn wire rolls
 - ✘ Check and replace if necessary
- ↗ Wire feed motor without supply voltage (automatic cutout triggered by overloading)
 - ✘ Reset triggered fuse (rear of the power source) by pressing the key button
- ↗ Kinked hose packages
 - ✘ Extend and lay out the torch hose package
- ↗ Wire guide core or spiral is dirty or worn
 - ✘ Clean core or spiral; replace kinked or worn cores

7.2 Error messages (power source)





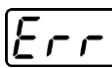
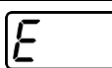









































The possible error numbers displayed depend on the machine series and version!

Depending on the options of the machine display, a fault is shown as follows:

Display type - machine control	Display
Graphic display	
two 7-segment displays	
one 7-segment display	

The possible cause of the fault is signalled by a corresponding fault number (see table). In the case of an error, the power unit shuts down.

- Document machine errors and inform service staff as necessary.
- If multiple errors occur, these are displayed in succession.
- Document machine errors and inform service staff as necessary.
- If multiple errors occur, these are displayed in succession.

	Category			Possible cause	Remedy
	a)	b)	c)		
1				Mains overvoltage	Check the mains voltages and compare with the connection voltages of the welding machine
2				Mains undervoltage	
3				Excess temperature of welding machine	Allow the machine to cool down (mains switch to "1")
4				Coolant error	Fill coolant Turn on pump shaft (coolant pump) Check overcurrent trip of air cooling unit
5				Wire feeder, tachometer error	Check the wire feeder tachometer generator sends no signal, motor control defective > inform Service.
6				Shielding gas error	Check shielding gas supply (for machines with shielding gas monitoring)
7				Overvoltage on secondary	Inverter error > inform Service
8				Wire error	Separate the electrical connection between welding wire and housing or an earthed object
9				Fast shutdown	Rectify error on robot (Interface for automated welding)
10				Arc interruption	Check wire feeding (interface for automated welding)
11				Ignition error (after 5 s)	Check wire feeding (interface for automated welding)
13				Emergency stop deactivation	Check the emergency stop switch of the interface for automated welding
14				Wire feeder detection	Check cable connections
				ID number allocation error (2DV)	Correct ID numbers
15				Detection of wire feeder 2	Check cable connections
16				Error in open circuit voltage reduction (VRD)	Inform Service.

Err	Category			Possible cause	Remedy
	a)	b)	c)		
17				Overcurrent detection on wire feeder	Check ease of wire feeding
18				Error in tachometer generator signal	Check the connection and particularly the tachometer generator of the second wire feeder (slave drive).
56				Mains phase failure	Check mains voltages
58				Short circuit	Check welding circuit for short circuit; put down welding torch isolated
59				Machine incompatible	Check machine usage
60				Software update required	Inform Service.

Category legend (resetting the error)

- a) The error message disappears when the error is eliminated.
- b) The error message can be reset by pressing a pushbutton.
Resetting the machine errors is only possible with the listed machine controls:

Machine control	Pushbutton
RC1 / RC2	
Expert	
Expert 2.0 / Expert XQ 2.0	
CarExpert / Progress (M3.11)	

- c) Error messages can only be reset by switching the machine off and on again.
The shielding gas error (Err 6) can be reset by pressing the "Welding parameters" key button.

7.3 Software version of the machine control

The query of the software versions only serves to inform the authorised service staff. It is available in the machine configuration menu > see 5.7 chapter.

7.4 Resetting welding parameters to the factory settings

All customised welding parameters that are stored will be replaced by the factory settings.

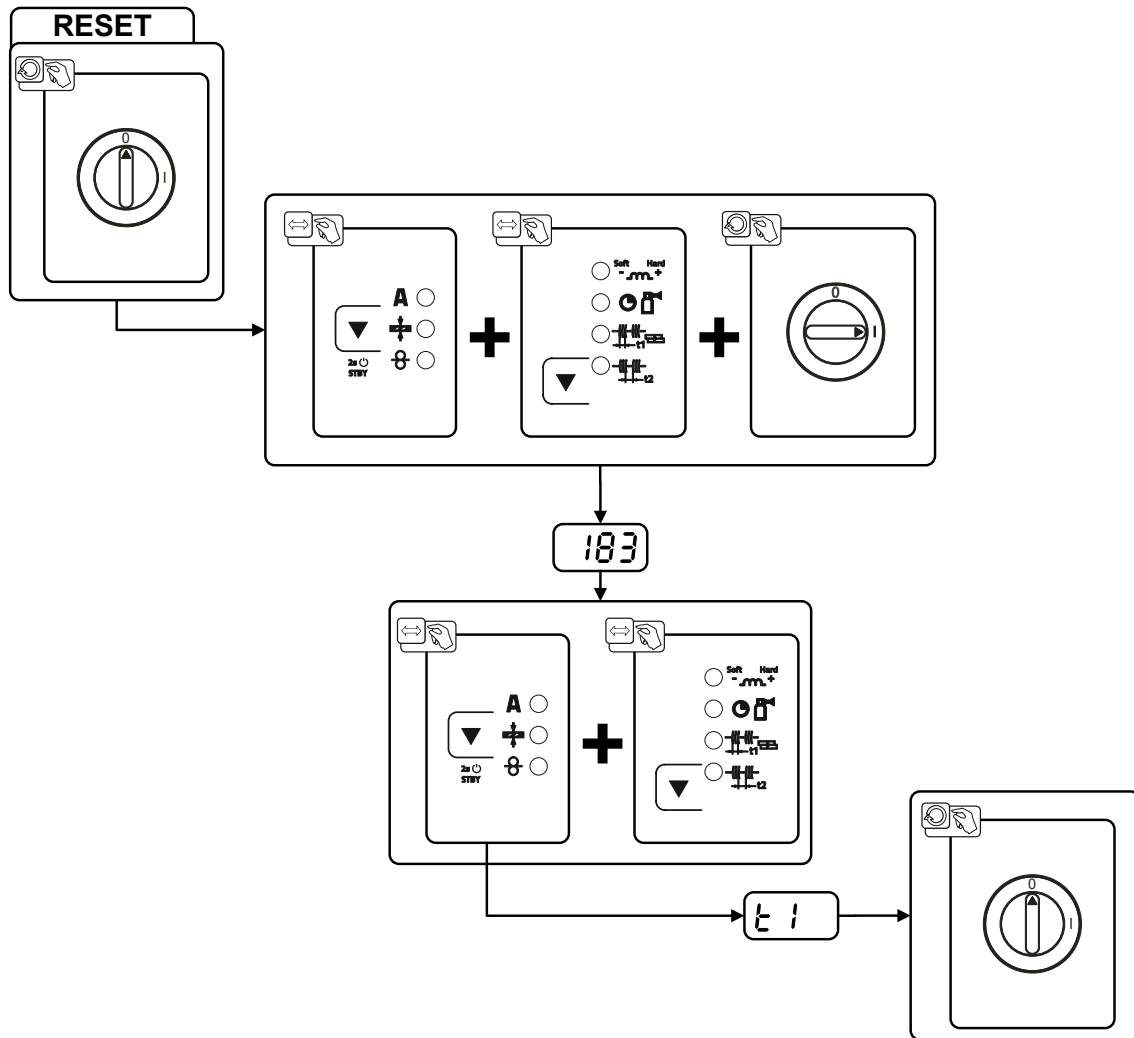

Figure 7-1

Display	Setting/selection
183	Code of machine control
t 1	Initialisation complete All customised welding parameters haven been overwritten by the factory settings.

7.5 Resetting JOBs (welding tasks) to the factory settings

7.5.1 Resetting a single JOB

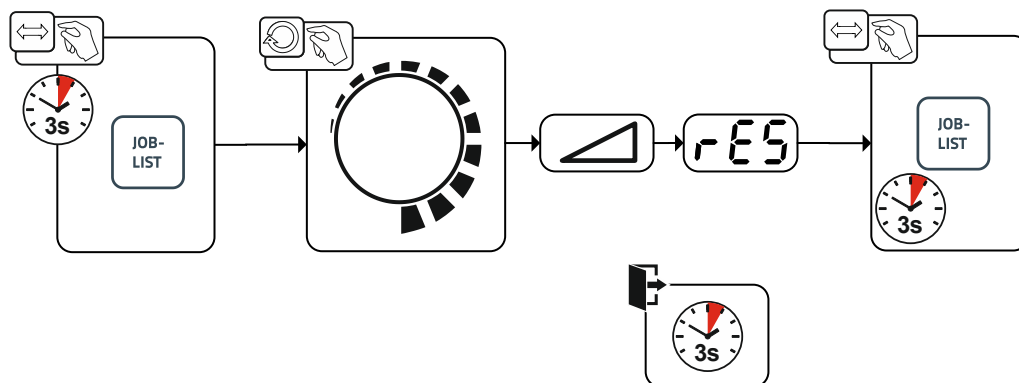

Figure 7-2

Display	Setting/selection
	RESET - to factory settings The RESET will be done after pressing the button. The menu will be ended when no changes are done after 3 sec.
	JOB-number - example The shown JOB will be set to ex works.

7.5.2 Resetting all JOBs

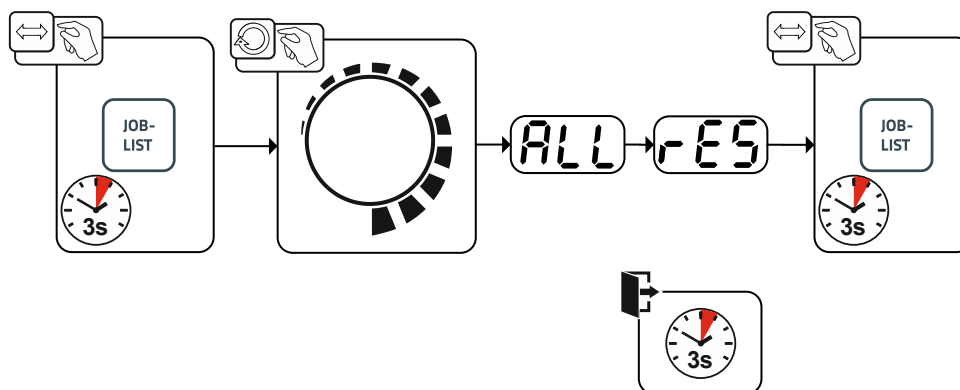

Figure 7-3

Display	Setting/selection
	RESET - to factory settings The RESET will be done after pressing the button. The menu will be ended when no changes are done after 3 sec.

7.6 Welding parameter calibration

In case of deviations between the welding parameters set on the front panel/remote control and those shown on the welding machine, this function allows for easy alignment.

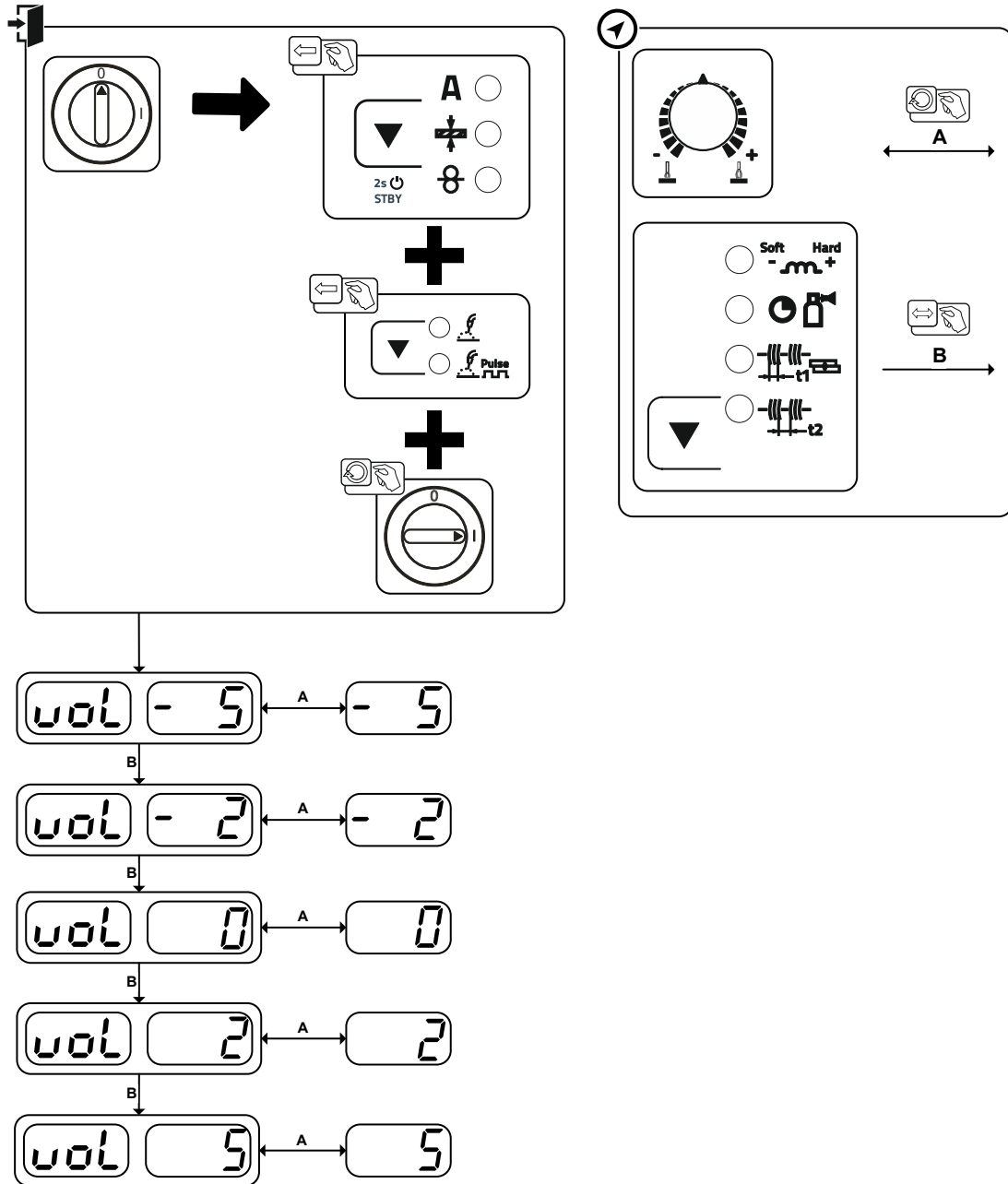

Figure 7-4

7.7 Vent coolant circuit

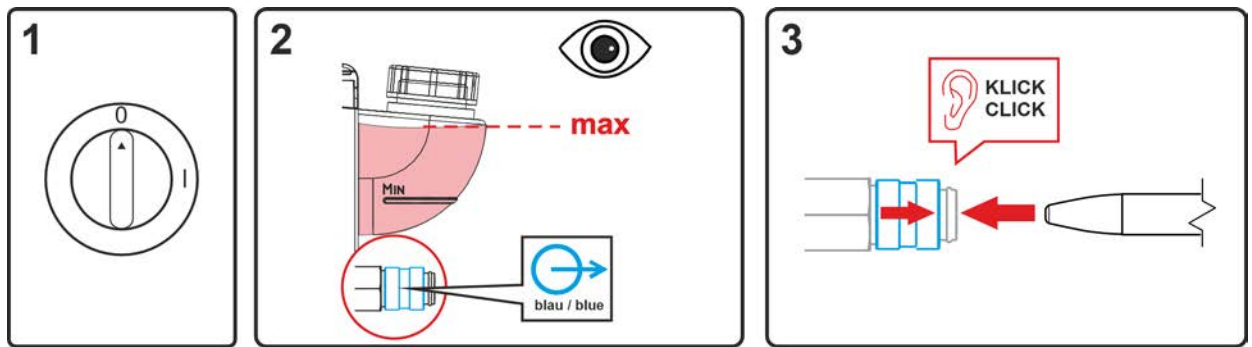

Figure 7-5

- Switch off the machine and fill the coolant tank to the maximum level.
- Unlock the quick-connect coupling with a suitable tool (connection open).

To vent the cooling system always use the blue coolant connection, which is located as deep as possible inside the system (close to the coolant tank)!

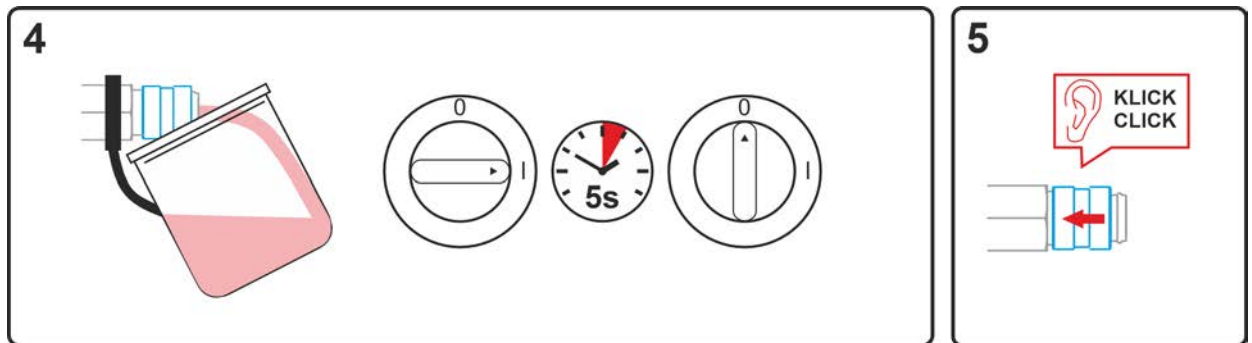





Figure 7-6

- Position a suitable collection container for collecting the escaping coolant at the quick-connect coupling and switch on the machine for approx. 5s.
- Lock the quick-connect coupling by pushing back the locking ring.

8 Technical data

8.1 Picomig 305 Synergic TKM

Performance specifications and guarantee only in connection with original spare and replacement parts!

	MIG/MAG	TIG	MMA
Welding current I ₂	5 A to 300 A	5 A to 300 A	5 A to 300 A
Welding voltage according to standard U ₂	14,3 V to 29 V	10,2 V to 22 V	20,2 V to 32,0 V
Duty cycle DC at 40°C/104°F ^[1]	300 A (35 %) / 240 A (60 %) / 190 A (100 %)		
Open circuit voltage U ₀	80 V		
Mains voltage (Tolerance)	3 x 400 V (-25 % to +20 %)		
Frequency	50/60 Hz		
mains fuse ^[2]	3 x 16 A	3 x 10 A	3 x 16 A
Mains connection cable	H07RN-F4G2,5		
max. Connected load S ₁	12,1 kVA	9,1 kVA	13,3 kVA
Recommended generator power	16,3 kVA	9,1 kVA	18,0 kVA
Power consumption P ₁	22 W		
Mains impedance (@PCC)	107 mOhm		
Cos φ / efficiency	0,99 / 88 %		
Protection class / Overvoltage category	I / III		
Contamination level	3		
Insulation class / protection classification	H / IP 23		
Residual current circuit breaker	Type B (recommended)		
Noise level ^[3]	<70 dB(A)		
Ambient temperature ^[4]	-25 °C to +40 °C / -13 °F to 104 °F		
Machine cooling / Torch cooling	Fan (AF) / gas		
Wire feed speed	0,5 m/min to 25m/min		
Factory-installed roll equipment	1,0/1,2 mm for steel wire		
Drive	4 rollers (37 mm)		
Wire spool diameter	Standardised wire spools up to 300 mm		
Welding torch connection	Euro torch connector		
Workpiece lead (min.)	50 mm ²		
EMC class	A		
Test mark	 /  /  / 		
Standards used	See declaration of conformity (appliance documents)		
Dimensions (l x b x h)	636 x 298 x 482 mm / 25.0 x 11.7 x 19.0 inch		
Weight	29,5 kg / 65 lb		

^[1] Load cycle: 10 min. (60 % DC \triangleq 6 min. welding, 4 min. pause) AC power sources: 50 Hz - waveform = square.

^[2] Safety fuses are recommended DIAZED xxA gG. When using automatic cutouts, the "C" trigger characteristic must be used.

^[3] Noise level during idle mode and operation under standard load according to IEC 60974-1 at the maximum operating point.

^[4] Ambient temperature dependent on coolant! Observe coolant temperature range!

9 Accessories

Performance-dependent accessories like torches, workpiece leads, electrode holders or intermediate hose packages are available from your authorised dealer.

9.1 Welding torch cooling system

Type	Designation	Item no.
Cool 55 C U40	Cooling unit with reinforced pump	090-008866-00502
Cool 55 C U42	Cooling unit with reinforced pump	090-008867-00502

9.2 Transport system

Type	Designation	Item no.
Trolley 35.2-2	Transport vehicle	090-008296-00000
Type	Designation	Item no.
Trolley 55-5	Transport cart, assembled	090-008632-00000
ON TR Trolley 55-5 / 55-6	Cross arm and holder for wire feeder	092-002700-00000
Type	Designation	Item no.
Trolley 55-6	Transport cart, assembled	090-008825-00000
ON TR Trolley 55-5 / 55-6	Cross arm and holder for wire feeder	092-002700-00000
Type	Designation	Item no.
Trolley 54	Transport vehicle	090-008639-00000
ON TG.03/04 MS TR.20/21	Assembly set for mounting on transport cart	092-004392-00000
Type	Designation	Item no.
Trolley 53	Transport cart	090-008638-00000
ON TG.03/04 MS TR.20/21	Assembly set for mounting on transport cart	092-004392-00000

9.3 Remote control/connecting and extension cable

9.3.1 19-pole connection

Type	Designation	Item no.
R10 19POL	Remote control	090-008087-00000
RG10 19POL 5M	Remote control to set the wire speed and welding voltage correction	090-008108-00000
RA5 19POL 5M	Remote control e.g. connection cable	092-001470-00005
RA10 19POL 10m	Remote control e.g. connection cable	092-001470-00010
RA20 19POL 20m	Remote control e.g. connection cable	092-001470-00020

9.4 Option for retrofitting

Type	Designation	Item no.
ON TH TG.03/TG.04/TG.11 R	Torch holder, right	092-002699-00000
ON TG	Carrying strap	092-004310-00000
ON Filter TG.0003	Dirt filter	092-002662-00000
ON CS T.005/TG.0003/D.0002	Crane suspension for Picomig 180 / 185 D3 / 305 D3, Phoenix and Taurus 355 compact, drive 4	092-002549-00000
ON D Barrel TG.0003	Wire guide Rolliner for drum feed	092-007929-00000
ON Case	Tool box for mounting to trolley Trolley 55-5 / Trolley 55-6	092-002899-00000
ON WAK TG.03/TG.04/TG.09/K.02	Wheel assembly kit	092-001356-00000
ON AL D13/27	Cap for load sockets	092-003282-00000

9.5 Shielding gas supply (shielding gas cylinder for welding machine)

Type	Designation	Item no.
Proreg Ar/CO2 230bar 15l D	Pressure regulator with manometer	394-008488-10015
Proreg Ar/CO2 230bar 30l D	Pressure regulator with manometer	394-008488-10030
DM 842 Ar/CO2 230bar 15l D	Pressure regulator with manometer	394-002910-00015
DM 842 Ar/CO2 230bar 30l D	Pressure regulator with manometer	394-002910-00030
GH 2X1/4" 2M	Gas hose	094-000010-00001
GH 2x1/4" 3m	Gas hose	094-000010-00003
GH 2X1/4" 5m	Gas hose	094-000010-00005
GH 2X1/4" 10 m	Gas hose	094-000010-00011
GH 2X1/4" 15m	Gas hose	094-000010-00015

9.6 General accessories

Type	Designation	Item no.
AK300	Wire spool adapter K300	094-001803-00001
CA D200	Centering adapter for 5-kg spools	094-011803-00000
16A 5POLE/CEE	Mains plug	094-000712-00000
DSP	Sharpener for liner	094-010427-00000
Cutter	Hose cutter	094-016585-00000
ADAP DZA/EZA	Adapter for welding torches with Dinse connector to Euro torch connector on the machine	094-016765-00000
CAPTUB L=107 mm; Ø ≤ 1,6 mm	Capillary tube	094-006634-00000
CAPTUB L=105 mm; Ø ≤ 2,4 mm	Capillary tube	094-021470-00000
GuideTube L=102 mm, Ø 4,4 x 5 mm	Guide tube	094-020064-00000

10 Replaceable parts

Performance specifications and guarantee only in connection with original spare and replacement parts!

10.1 Wire feed rollers

10.1.1 Wire feed rollers for steel wire

Type	Designation	Item no.
FE 4R 0.6 MM/0.023 INCH LIGHT PINK	Drive roll set, 37 mm, 4 rolls, V-groove for steel, stainless steel and brazing	092-002770-00006
FE 4R 0.8-1.0MM / 0.03-0.04 INCH BLUE/WHITE	Drive roll set, 37 mm, 4 rolls, V-groove for steel, stainless steel and brazing	092-002770-00009
FE 4R 1.0-1.2MM / 0.04-0.045 INCH BLUE/RED	Drive roll set, 37 mm, 4 rolls, V-groove for steel, stainless steel and brazing	092-002770-00011
FE 4R 1.4 MM/0.052 INCH GREEN	Drive roll set, 37 mm, 4 rolls, V-groove for steel, stainless steel and brazing	092-002770-00014
FE 4R 1.6 MM/0.06 INCH BLACK	Drive roll set, 37 mm, 4 rolls, V-groove for steel, stainless steel and brazing	092-002770-00016
FE 4R 2.0 MM/0.08 INCH GREY	Drive roll set, 37 mm, 4 rolls, V-groove for steel, stainless steel and brazing	092-002770-00020
FE 4R 2.4 MM/0.095 INCH BROWN	Drive roll set, 37 mm, 4 rolls, V-groove for steel, stainless steel and brazing	092-002770-00024
FE 4R 2.8 MM/0.11 INCH LIGHT GREEN	Drive roll set, 37 mm, 4 rolls, V-groove for steel, stainless steel and brazing	092-002770-00028
FE 4R 3.2 MM/0.12 INCH VIOLET	Drive roll set, 37 mm, 4 rolls, V-groove for steel, stainless steel and brazing	092-002770-00032

10.1.2 Wire feed rollers for aluminium wire

Type	Designation	Item no.
AL 4R 0.8 MM/0.03 INCH WHITE/YELLOW	Drive roll set, 37 mm, for aluminium	092-002771-00008
AL 4R 1.0 MM/0.04 INCH BLUE/YELLOW	Drive roll set, 37 mm, for aluminium	092-002771-00010
AL 4R 1.2 MM/0.045 INCH RED/YELLOW	Drive roll set, 37 mm, for aluminium	092-002771-00012
AL 4R 1.6 MM/0.06 INCH BLACK/YELLOW	Drive roll set, 37 mm, for aluminium	092-002771-00016
AL 4R 2.0 MM/0.08 INCH GREY/YELLOW	Drive roll set, 37 mm, for aluminium	092-002771-00020
AL 4R 2.4 MM/0.095 INCH BROWN/YELLOW	Drive roll set, 37 mm, for aluminium	092-002771-00024
AL 4R 2.8 MM/0.110 INCH LIGHT GREEN/YELLOW	Drive roll set, 37 mm, for aluminium	092-002771-00028
AL 4R 3.2 MM/0.125 INCH VIOLET/YELLOW	Drive roll set, 37 mm, for aluminium	092-002771-00032

10.1.3 Wire feed rollers for cored wire

Type	Designation	Item no.
FUEL 4R 0.8 MM/0.03 INCH WHITE/ORANGE	Drive roll set, 37 mm, 4 rolls, V-groove/knurled for flux cored wire	092-002848-00008
FUEL 4R 1.0 MM/0.04 INCH BLUE/ORANGE	Drive roll set, 37 mm, 4 rolls, V-groove/knurled for flux cored wire	092-002848-00010
FUEL 4R 1.2 MM/0.045 INCH RED/ORANGE	Drive roll set, 37 mm, 4 rolls, V-groove/knurled for flux cored wire	092-002848-00012
FUEL 4R 1.4 MM/0.052 INCH GREEN/ORANGE	Drive roll set, 37 mm, 4 rolls, V-groove/knurled for flux cored wire	092-002848-00014
FUEL 4R 1.6 MM/0.06 INCH BLACK/ORANGE	Drive roll set, 37 mm, 4 rolls, V-groove/knurled for flux cored wire	092-002848-00016
FUEL 4R 2.0 MM/0.08 INCH GREY/ORANGE	Drive roll set, 37 mm, 4 rolls, V-groove/knurled for flux cored wire	092-002848-00020
FUEL 4R 2.4 MM/0.095 INCH BROWN/ORANGE	Drive roll set, 37 mm, 4 rolls, V-groove/knurled for flux cored wire	092-002848-00024

10.1.4 Wire guide

Type	Designation	Item no.
DV X	Wire feed roll mount set	092-002960-E0000
SET WF 1,6mm eFeed	Wire feed set for rolls up to 1.6 mm in diameter	092-002774-00000
ON SET WF 2,0-3,2mm eFeed	Wire feed set for rolls with diameters greater than 1.6 mm	092-019404-00000
SET IG 4x4 1.6mm BL	Inlet guide set	092-002780-00000
GUIDE TUBE L105	Guide tube	094-006051-00000
GuideTube L=102 mm, Ø 4,4 x 5 mm	Guide tube	094-020064-00000
CAPTUB L=107 mm; Ø ≤ 1,6 mm	Capillary tube	094-006634-00000
CAPTUB L=105 mm; Ø ≤ 2,4 mm	Capillary tube	094-021470-00000

11 Appendix

11.1 JOB-List

Massivdraht solid wire		Ø inch mm				
Symbol	Shielding Gas	.023	.030	.035	.040	.045
		0,6	0,8	0,9	1,0	1,2
JOB						
SG2/3 G3/4 Si1	CO ₂ -100 / C1	176	1	2	3	4
	Ar-82/CO ₂ -18 M20 - M21	175	6	7	8	9
CrNi	Ar-97,5/CO ₂ -2,5 M12		34	223	35	36
CuSi Löten / Brazing	Ar-100 / I1		114	177	115	116
	Ar97,5/CO ₂ -2,5 M12		110	178	111	112
CuAl Löten / Brazing	Ar-100 / I1		122		123	124
	Ar97,5/CO ₂ -2,5 M12		118		119	120
AlMg	Ar-100 / I1		74		75	76
	Ar-70/He-30 / I3		78		79	80
AlSi	Ar-100 / I1		82		83	84
	Ar-70/He-30 / I3		86		87	88
Al99	Ar-100 / I1		90		91	92
	Ar-70/He-30 / I3		94		95	96

Fülldraht metal / flux-cored		Ø inch mm				
Symbol	Shielding Gas	.030	.035	.040	.043	.045
		0,8	0,9	1,0	1,1	1,2
JOB						
E70C Metal	Ar-82/CO ₂ -18 M20 - M21	235	236	237		238
E71T Rutile	Ar-82/CO ₂ -18 M20 - M21	240	241	242		243
	CO ₂ -100 / C1		246	247		248
E71T	Self-Shielded		172		171	170
CrNi	Metal	Ar-97,5/CO ₂ -2,5 M12	227		228	229
		Ar-82/CO ₂ -18 M20 - M21	231		232	233
	Rutil / Basic	CO ₂ -100 / C1	210		211	212

forceArc		Ø inch mm		
Symbol	Shielding Gas	.030	.040	.045
		0,8	1,0	1,2
JOB				
SG2/3 G3/4 Si1	Ar-82/CO ₂ -18 M21	189	179	
	Ar-90/CO ₂ -10 M20	190	254	

rootArc		Ø inch mm		
Symbol	Shielding Gas	.030	.040	.045
		0,8	1,0	1,2
JOB				
SG2/3 G3/4 Si1	CO ₂ -100 / C1		204	205
	Ar-82/CO ₂ -18 M20 - M21		206	207

MIG / MAG GMAW	
manual non synergic	188

Zusatz additional	
WIG TIG	127
E-Hand MMA	128

pulse only in Picomig puls Version	
Standard	standard
Standard / Puls	standard / pulse

color-code	
Orange	Stahl / mild steel
Yellow	Edelstahl / stainless steel
Light Yellow	Aluminium / aluminium

Figure 11-1

All JOBS marked in blue can be used for pulsed and standard arc welding.

When trying to switch a non-pulse arc capable JOB to pulsed arc welding, the machine displays the message (no pulse) and switches back to standard arc welding.

11.2 Parameter overview – setting ranges

Welding data display (three-digit)	Parameter / function	Setting range			
		Standard (factory set)	Min.	Max.	Unit
MIG/MAG					
	Gas pre-flow time	JOB ^[1]	0,0 - 20,0		s
	Start current (percentage of main current)	JOB ^[1]	0 - 200		%
	Ignition current time	JOB ^[1]	0,0 - 20,0		s
	Slope time (duration from start current to main current)	JOB ^[1]	0,0 - 20,0		s
	Slope time (duration from main current to end current)	JOB ^[1]	0,0 - 20,0		s
	End current (percentage of main current)	JOB ^[1]	0 - 200		%
	End current time	JOB ^[1]	0,0 - 20,0		s
	Dynamic correction	0	-40 - 40		
	Gas post-flow time	JOB ^[1]	0,0 - 20,0		s
	Spot time	JOB ^[1]	0,1 - 20,0		s
	Pause time (interval)	JOB ^[1]	0,1 - 20,0		s
	Wire burn-back	JOB ^[1]	0 - 499		%
TIG					
	Gas pre-flow time	0,1	0,0 - 20,0		s
	Start current	70	0 - 200		%
	Up-slope time	0,5	0,0 - 20,0		s
	Down-slope time	0,5	0,0 - 20,0		s
	End current	50	1 - 200		%
	Gas post-flow time	5,0	0,0 - 20,0		s
MMA					
	Arcforce correction	0	-40 - 40		
	Hot start current	120	0 - 200		%
	Hot start time	0,5	0 - 20,0		s

^[1] Values are or will be saved separately in each JOB .

11.3 Average wire electrode usage

5 m/min – 197 ipm								
	mm				inch			
	1.0	1.2	1.6		.040	.045	.060	
Steel	1.8	2.7	4.7	kg/h	3.9	5.9	10.3	lb/h
Stainless steel	1.9	2.8	4.8		4.1	6.1	10.5	
Aluminium	0.6	0.9	1.6		1.3	1.9	3.5	
10 m/min – 394 ipm								
Steel	3.7	5.3	9.5	kg/h	8.1	11.6	20.9	lb/h
Stainless steel	3.8	5.4	9.6		8.3	11.9	21.1	
Aluminium	1.3	1.8	3.2		2.8	3.9	7.0	

11.4 Average shielding gas usage

11.4.1 MIG/MAG welding

	mm	1.0	1.2	1.6	2.0
	inch	.040	.045	.060	.080
l/min		10	12	16	20
gal/min		2.64	3.17	4.22	5.28

11.4.2 TIG welding

	Gas nozzle number	4	5	6	7	8	10
	∅ mm	6.5	8.0	9.5	11	12.5	16
	∅ inch	0.26	0.31	0.37	0.43	0.5	0.63
l/min		6	8	10	12		15
gal/min		1.58	2.11	2.64	3.17		3.96

11.5 Searching for a dealer

Sales & service partners
www.ewm-group.com/en/specialist-dealers



"More than 400 EWM sales partners worldwide"