



EN

Welding machine

Picotig 220 puls DC 5P

099-002068-EW501

Observe additional system documents!

11.06.2024

**Register now
and benefit!
Jetzt Registrieren
und Profitieren!**

www.ewm-group.com



General instructions

WARNING



Read the operating instructions!

The operating instructions provide an introduction to the safe use of the products.

- Read and observe the operating instructions for all system components, especially the safety instructions and warning notices!
- Observe the accident prevention regulations and any regional regulations!
- The operating instructions must be kept at the location where the machine is operated.
- Safety and warning labels on the machine indicate any possible risks. Keep these labels clean and legible at all times.
- The machine has been constructed to state-of-the-art standards in line with any applicable regulations and industrial standards. Only trained personnel may operate, service and repair the machine.
- Technical changes due to further development in machine technology may lead to a differing welding behaviour.

In the event of queries on installation, commissioning, operation or special conditions at the installation site, or on usage, please contact your sales partner or our customer service department on +49 2680 181-0.

A list of authorised sales partners can be found at www.ewm-group.com/en/specialist-dealers.

Liability relating to the operation of this equipment is restricted solely to the function of the equipment. No other form of liability, regardless of type, shall be accepted. This exclusion of liability shall be deemed accepted by the user on commissioning the equipment.

The manufacturer is unable to monitor whether or not these instructions or the conditions and methods are observed during installation, operation, usage and maintenance of the equipment.

An incorrectly performed installation can result in material damage and injure persons as a result. For this reason, we do not accept any responsibility or liability for losses, damages or costs arising from incorrect installation, improper operation or incorrect usage and maintenance or any actions connected to this in any way.

© EWM GmbH

Dr. Günter-Henle-Strasse 8

56271 Mündersbach Germany

Tel.: +49 2680 181-0, Fax: -244

Email: info@ewm-group.com

www.ewm-group.com

The copyright to this document remains the property of the manufacturer.

Copying, including extracts, only permitted with written approval.

The content of this document has been prepared and reviewed with all reasonable care. The information provided is subject to change; errors excepted.

Data security

The user is responsible for backing up data of all changes from the factory setting. The user is liable for erased personal settings. The manufacturer does not assume any liability for this.

1 Contents

1	Contents	3
2	For your safety	7
2.1	Notes on using these operating instructions.....	7
2.2	Explanation of icons.....	8
2.3	Safety instructions.....	9
2.4	Transport and installation	12
3	Intended use	14
3.1	Applications.....	14
3.2	Software version	14
3.3	Documents which also apply	14
3.3.1	Warranty	14
3.3.2	Declaration of Conformity.....	14
3.3.3	Welding in environments with increased electrical hazards.....	14
3.3.4	Service documents (spare parts and circuit diagrams).....	14
3.3.5	Calibration/Validation	14
3.3.6	Part of the complete documentation.....	15
4	Machine description – quick overview	16
4.1	Front view / rear view.....	16
4.2	Machine control – Operating elements	18
4.2.1	Overview of control sections	18
4.2.1.1	Control section A.....	19
4.2.1.2	Control section B.....	20
4.3	Operating the machine control.....	21
4.3.1	Main screen	21
4.3.2	Welding parameter setting in the operation sequence.....	21
4.3.3	Setting advanced welding parameters (Expert menu)	21
4.3.4	Changing basic settings (machine configuration menu)	21
4.3.5	Lock function	21
5	Design and function	22
5.1	Transport and installation	22
5.1.1	Transport belt	22
5.1.1.1	Adjusting the length of the carrying strap	22
5.1.2	Ambient conditions	23
5.1.3	Machine cooling.....	23
5.1.4	Workpiece lead, general.....	23
5.1.5	Dirt filter	23
5.1.6	Notes on the installation of welding current leads.....	24
5.1.7	Mains connection.....	24
5.1.7.1	Mains configuration.....	25
5.1.8	Protective flap, welding machine control.....	26
5.1.9	Wear part compartment.....	26
5.2	TIG welding.....	27
5.2.1	Welding torch and workpiece line connection	27
5.2.1.1	Control lead connection	27
5.2.2	Shielding gas supply (shielding gas cylinder for welding machine)	28
5.2.2.1	Pressure regulator connection	28
5.2.2.2	Shielding gas hose connection	29
5.2.2.3	Setting the shielding gas volume (gas test)/rinse hose package.....	29
5.2.2.4	Automatic gas post-flow.....	29
5.2.3	Setting welding procedure	30
5.2.3.1	Basic setting (tungsten electrode diameter)	30
5.2.4	Arc ignition.....	31
5.2.4.1	HF ignition	31
5.2.4.2	Liftarc	31
5.2.4.3	Automatic cut-out.....	31
5.2.5	Operating modes (functional sequences)	32
5.2.5.1	Explanation of symbols	32
5.2.5.2	Non-latched mode.....	33

5.2.5.3	Latched mode.....	34
5.2.5.4	spotArc	35
5.2.5.5	spotmatic	36
5.2.6	Pulse welding.....	38
5.2.6.1	Average value pulse welding	38
5.2.6.2	Automated pulses.....	38
5.2.7	Welding torch (operating variants).....	39
5.2.7.1	Welding torch mode	39
5.2.7.2	Tapping function (tap torch trigger)	40
5.2.7.3	Up/down speed	40
5.2.7.4	Current jump.....	40
5.2.8	RTF 1 foot-operated remote control	40
5.2.8.1	Response	41
5.2.8.2	Start program	41
5.2.8.3	Start/stop operation	42
5.2.9	Expert menu (TIG).....	42
5.3	MMA welding.....	43
5.3.1	Connecting the electrode holder and workpiece lead	43
5.3.2	Setting welding procedure	43
5.3.3	Hotstart	43
5.3.3.1	Hotstart current.....	44
5.3.3.2	Hotstart time	44
5.3.4	Arcforce.....	44
5.3.5	Antistick.....	44
5.3.6	Pulse welding.....	45
5.3.6.1	Average value pulse welding	45
5.3.7	Arc length restriction (USP)	46
5.3.8	Expert menu (MMA).....	46
5.4	Remote control.....	46
5.4.1	RTF-X TIG 19Pol	46
5.4.2	RTF1 19POL.....	46
5.4.3	RT1 19POL.....	46
5.4.4	RTG1 19POL	47
5.4.5	RTA PWS2	47
5.5	Power-saving mode (Standby).....	47
5.6	Access control.....	47
5.7	Machine configuration menu	48
5.7.1	Selecting, changing and saving parameters.....	48
6	Maintenance, care and disposal	51
6.1	General.....	51
6.1.1	Cleaning.....	51
6.1.2	Dirt filter.....	51
6.2	Maintenance work, intervals	52
6.2.1	Daily maintenance tasks.....	52
6.2.2	Monthly maintenance tasks	52
6.2.3	Annual test (inspection and testing during operation)	52
6.3	Calibration and validation mode.....	53
6.3.1	Machine control – Operating elements.....	53
6.3.2	Activating the calibration and validation mode	54
6.3.3	Turning the inverter of the power source on and off.....	54
6.3.4	Deactivating the calibration and validation mode	54
6.4	Disposing of equipment.....	55
7	Rectifying faults.....	56
7.1	Software version of the machine control.....	56
7.2	Error messages (power source).....	56
7.3	Warnings	63
7.4	Checklist for rectifying faults	64
7.5	Voltage reducing device.....	66
7.6	Dynamic power adjustment.....	66
7.7	Resetting welding parameters to the factory settings	66

8	Technical data	67
8.1	Picotig 220 puls DC 5P	67
8.1.1	Mains voltage 230 V	67
8.1.2	Mains voltage 120 V	68
9	Accessories	69
9.1	Shielding gas supply (shielding gas cylinder for welding machine).....	69
9.2	Transport system	69
9.3	19-pole remote control	69
9.3.1	Connection cables	69
9.4	Option for retrofitting	69
9.5	General accessories	69
10	Appendix	70
10.1	Parameter overview – setting ranges	70
10.1.1	TIG welding	70
10.1.2	MMA welding	71
10.1.3	Basic parameters (independent of process)	71
10.2	Average shielding gas usage.....	71
10.3	Searching for a dealer	72

2 For your safety

2.1 Notes on using these operating instructions

DANGER

Working or operating procedures which must be closely observed to prevent imminent serious and even fatal injuries.

- Safety notes include the "DANGER" keyword in the heading with a general warning symbol.
- The hazard is also highlighted using a symbol on the edge of the page.

WARNING

Working or operating procedures which must be closely observed to prevent serious and even fatal injuries.

- Safety notes include the "WARNING" keyword in the heading with a general warning symbol.
- The hazard is also highlighted using a symbol in the page margin.

CAUTION

Working or operating procedures which must be closely observed to prevent possible minor personal injury.

- The safety information includes the "CAUTION" keyword in its heading with a general warning symbol.
- The risk is explained using a symbol on the edge of the page.



Technical aspects which the user must observe to avoid material or equipment damage.

Instructions and lists detailing step-by-step actions for given situations can be recognised via bullet points, e.g.:

- Insert the welding current lead socket into the relevant socket and lock.

2.2 Explanation of icons

Symbol	Description	Symbol	Description
	Indicates technical aspects which the user must observe.		Activate and release / Tap / Tip
	Switch off machine		Release
	Switch on machine		Press and hold
	Incorrect / Invalid		Switch
	Correct / Valid		Turn
	Input		Numerical value – adjustable
	Navigation		Signal light lights up in green
	Output		Signal light flashes green
	Time representation (e.g.: wait 4 s / actuate)		Signal light lights up in red
	Interruption in the menu display (other setting options possible)		Signal light flashes red
	Tool not required/do not use		Signal light lights up in blue
	Tool required/use		Signal light flashes blue

2.3 Safety instructions

WARNING



Risk of accidents due to non-compliance with the safety instructions!
Non-compliance with the safety instructions can be fatal!

- Carefully read the safety instructions in this manual!
- Observe the accident prevention regulations and any regional regulations!
- Inform persons in the working area that they must comply with the regulations!



Risk of injury from electrical voltage!

Voltages can cause potentially fatal electric shocks and burns on contact. Even low voltages can cause a shock and lead to accidents.

- Never touch live components such as welding current sockets or stick, tungsten or wire electrodes!
- Always place torches and electrode holders on an insulated surface!
- Wear the full personal protective equipment (depending on the application)!
- The machine may only be opened by qualified personnel!
- The device must not be used to defrost pipes!



Hazard when interconnecting multiple power sources!

If a number of power sources are to be connected in parallel or in series, only a technical specialist may interconnect the sources as per standard IEC 60974-9:2010: Installation and use and German Accident Prevention Regulation BVG D1 (formerly VBG 15) or country-specific regulations.

Before commencing arc welding, a test must verify that the equipment cannot exceed the maximum permitted open circuit voltage.

- Only qualified personnel may connect the machine.
- When taking individual power sources out of operation, all mains and welding current leads must be safely disconnected from the welding system as a whole. (Hazard due to reverse polarity voltage!)
- Do not interconnect welding machines with pole reversing switch (PWS series) or machines for AC welding since a minor error in operation can cause the welding voltages to be combined, which is not permitted.



Risk of injury due to radiation or heat!

Arc radiation can lead to skin and eye injuries.

Contact with hot workpieces and sparks can lead to burns.

- Use hand shield or welding helmet with the appropriate safety level (depends on the application).
- Wear dry protective clothing (e.g. hand shield, gloves, etc.) in accordance with the applicable regulations of your country.
- Persons who are not directly involved should be protected with a welding curtain or suitable safety screen against radiation and the risk of blinding!

WARNING



Risk of injury due to improper clothing!

During arc welding, radiation, heat and voltage are sources of risk that cannot be avoided. The user has to be equipped with the complete personal protective equipment at all times. The protective equipment has to include:

- Respiratory protection against hazardous substances and mixtures (fumes and vapours); otherwise implement suitable measures such as extraction facilities.
- Welding helmet with proper protection against ionizing radiation (IR and UV radiation) and heat.
- Dry welding clothing (shoes, gloves and body protection) to protect against warm environments with conditions comparable to ambient temperatures of 100 °C or higher and arcing and work on live components.
- Hearing protection against harming noise.



Explosion risk!

Apparently harmless substances in closed containers may generate excessive pressure when heated.

- Move containers with inflammable or explosive liquids away from the working area!
- Never heat explosive liquids, dusts or gases by welding or cutting!



Fire hazard!

Due to the high temperatures, sparks, glowing parts and hot slag that occur during welding, there is a risk of flames.

- Be watchful of potential sources of fire in the working area!
- Do not carry any easily inflammable objects, e.g. matches or lighters.
- Ensure suitable fire extinguishers are available in the working area!
- Thoroughly remove any residue of flammable materials from the workpiece prior to starting to weld.
- Only further process workpieces after they have cooled down. Do not allow them to contact any flammable materials!

⚠ CAUTION**Smoke and gases!**

Smoke and gases may lead to shortness of breath and poisoning! The ultraviolet radiation of the arc may also convert solvent vapours (chlorinated hydrocarbon) into poisonous phosgene.

- Ensure sufficient fresh air!
- Keep solvent vapours away from the arc beam field!
- Wear suitable respiratory protection if necessary!
- To prevent the formation of phosgene, residues of chlorinated solvents on workpieces must first be neutralised using appropriate measures.

**Noise exposure!**

Noise exceeding 70 dBA can cause permanent hearing damage!

- Wear suitable ear protection!
- Persons located within the working area must wear suitable ear protection!



According to IEC 60974-10, welding machines are divided into two classes of electromagnetic compatibility (the EMC class can be found in the Technical data) > see 8 chapter:



Class A machines are not intended for use in residential areas where the power supply comes from the low-voltage public mains network. When ensuring the electromagnetic compatibility of class A machines, difficulties can arise in these areas due to interference not only in the supply lines but also in the form of radiated interference.



Class B machines fulfil the EMC requirements in industrial as well as residential areas, including residential areas connected to the low-voltage public mains network.

Setting up and operating

When operating arc welding systems, in some cases, electro-magnetic interference can occur although all of the welding machines comply with the emission limits specified in the standard. The user is responsible for any interference caused by welding.

In order to **evaluate** any possible problems with electromagnetic compatibility in the surrounding area, the user must consider the following: (see also EN 60974-10 Appendix A)

- Mains, control, signal and telecommunication lines
- Radios and televisions
- Computers and other control systems
- Safety equipment
- The health of neighbouring persons, especially if they have a pacemaker or wear a hearing aid
- Calibration and measuring equipment
- The immunity to interference of other equipment in the surrounding area
- The time of day at which the welding work must be carried out

Recommendations for reducing interference emission

- Mains connection, e.g. additional mains filter or shielding with a metal tube
- Maintenance of the arc welding system
- Welding leads should be as short as possible and run closely together along the ground
- Potential equalization
- Earthing of the workpiece. In cases where it is not possible to earth the workpiece directly, it should be connected by means of suitable capacitors.
- Shielding from other equipment in the surrounding area or the entire welding system

**Electromagnetic fields!**

The power source can create electrical or electromagnetic fields that may impair the function of electronic systems such as EDP and CNC devices, telecommunication, power and signal lines as well as pacemakers and defibrillators.



- Follow the maintenance instructions > see 6 chapter!
- Unwind the welding leads completely!
- Shield radiation-sensitive equipment or facilities appropriately!
- The function of pacemakers may be impaired (seek medical advice if necessary).

CAUTION



Obligations of the operator!

The respective national directives and laws must be complied with when operating the machine!

- Implementation of national legislation relating to framework directive 89/391/EEC on the introduction of measures to encourage improvements in the safety and health of workers at work and associated individual guidelines.
- In particular, directive 89/655/EEC concerning the minimum safety and health requirements for the use of work equipment by workers at work.
- The regulations applicable to occupational safety and accident prevention in the country concerned.
- Setting up and operating the machine as per IEC 60974.-9.
- Brief the user on safety-conscious work practices on a regular basis.
- Regularly inspect the machine as per IEC 60974.-4.



The manufacturer's warranty becomes void if non-genuine parts are used!

- ***Only use system components and options (power sources, welding torches, electrode holders, remote controls, spare parts and replacement parts, etc.) from our range of products!***
- ***Only insert and lock accessory components into the relevant connection socket when the machine is switched off.***

Requirements for connection to the public mains network

High-performance machines can influence the mains quality by taking current from the mains network. For some types of machines, connection restrictions or requirements relating to the maximum possible line impedance or the necessary minimum supply capacity at the interface with the public network (Point of Common Coupling, PCC) can therefore apply. In this respect, attention is also drawn to the machines' technical data. In this case, it is the responsibility of the operator, where necessary in consultation with the mains network operator, to ensure that the machine can be connected.

2.4 Transport and installation

WARNING



Risk of injury due to improper handling of shielding gas cylinders!

Improper handling and insufficient securing of shielding gas cylinders can cause serious injuries!

- Observe the instructions from the gas manufacturer and any relevant regulations concerning the use of compressed air!
- Do not attach any element to the shielding gas cylinder valve!
- Prevent the shielding gas cylinder from heating up.

⚠ CAUTION**Risk of accidents due to supply lines!**

During transport, attached supply lines (mains leads, control cables, etc.) can cause risks, e.g. by causing connected machines to tip over and injure persons!

- Disconnect all supply lines before transport!

**Risk of tipping!**

There is a risk of the machine tipping over and injuring persons or being damaged itself during movement and set up. Tilt resistance is guaranteed up to an angle of 10° (according to IEC 60974-1).

- Set up and transport the machine on level, solid ground.
- Secure add-on parts using suitable equipment.

**Risk of accidents due to incorrectly installed leads!**

Incorrectly installed leads (mains, control and welding leads or intermediate hose packages) can present a tripping hazard.

- Lay the supply lines flat on the floor (avoid loops).
- Avoid laying the leads on passage ways.

**Risk of injury from heated coolant and its connections!**

The coolant used and its connection or connection points can heat up significantly during operation (water-cooled version). When opening the coolant circuit, escaping coolant may cause scalding.

- Open the coolant circuit only when the power source or cooling unit is switched off!
- Wear proper protective equipment (protective gloves)!
- Seal open connections of the hose leads with suitable plugs.



The units are designed for operation in an upright position!

Operation in non-permissible positions can cause equipment damage.

- ***Only transport and operate in an upright position!***



Accessory components and the power source itself can be damaged by incorrect connection!

- ***Only insert and lock accessory components into the relevant connection socket when the machine is switched off.***
- ***Comprehensive descriptions can be found in the operating instructions for the relevant accessory components.***
- ***Accessory components are detected automatically after the power source is switched on.***



Protective dust caps protect the connection sockets and therefore the machine against dirt and damage.

- ***The protective dust cap must be fitted if there is no accessory component being operated on that connection.***
- ***The cap must be replaced if faulty or if lost!***

3 Intended use

WARNING



Hazards due to improper usage!

The machine has been constructed to the state of the art and any regulations and standards applicable for use in industry and trade. It may only be used for the welding procedures indicated at the rating plate. Hazards may arise for persons, animals and material objects if the equipment is not used correctly. No liability is accepted for any damages arising from improper usage!

- The equipment must only be used in line with its designated purpose and by trained or expert personnel!
- Do not improperly modify or convert the equipment!

3.1 Applications

Arc welding machines for TIG DC welding with lift arc (touch starting) or HF ignition (contactless) and MMA welding as secondary process. It may be possible to expand the functionality by using accessories (see the documentation in the relevant chapter).

3.2 Software version

The software version of the machine control can be displayed in the machine configuration menu (menu Srv) > see 5.7 chapter.

3.3 Documents which also apply

3.3.1 Warranty

For more information refer to the "Warranty registration" brochure supplied and our information regarding warranty, maintenance and testing at www.ewm-group.com!

3.3.2 Declaration of Conformity



This product corresponds in its design and construction to the EU directives listed in the declaration. The product comes with a relevant declaration of conformity in the original.

The manufacturer recommends carrying out the safety inspection according to national and international standards and guidelines every 12 months (from commissioning).

3.3.3 Welding in environments with increased electrical hazards



Power sources with this marking can be used for welding in an environment with increased electrical hazard (e.g. boilers). For this purpose, appropriate national or international regulations must be followed. The power source must not be placed in the danger zone!

3.3.4 Service documents (spare parts and circuit diagrams)

WARNING



No improper repairs and modifications!

To prevent injuries and damage to the machine, only competent personnel (authorised service personnel) are allowed to repair or modify the machine.

Unauthorised manipulations will invalidate the warranty!

- Instruct competent personnel (authorised service personnel) to repair the machine.

Original copies of the circuit diagrams are enclosed with the unit.

Spare parts can be obtained from the relevant authorised dealer.

3.3.5 Calibration/Validation

An original certificate is enclosed with the product. The manufacturer recommends calibration / validation at intervals of 12 months (from commissioning).

3.3.6 Part of the complete documentation

This document is part of the complete documentation and valid only in combination with all other parts of these instructions! Read and observe the operating instructions for all system components, especially the safety instructions!

The illustration shows a general example of a welding system.

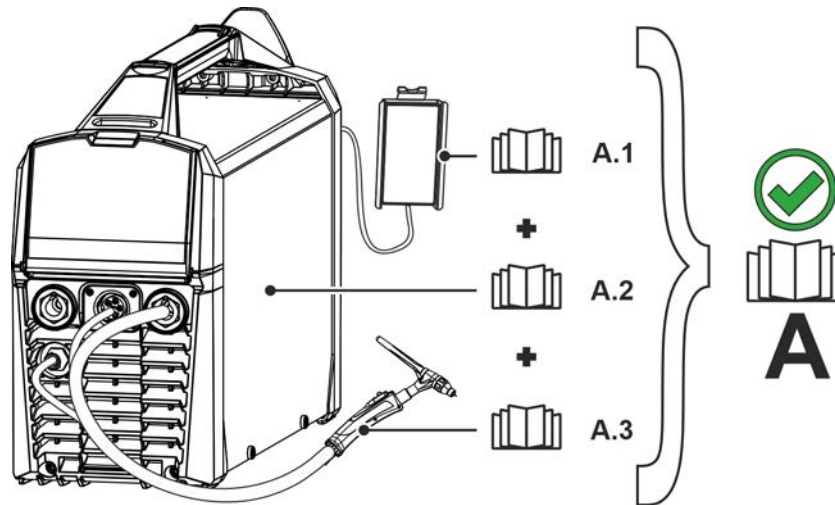

Figure 3-1

Item	Documentation
A.1	Remote control
A.2	Power source
A.3	Welding torch
A	Complete documentation

4 Machine description – quick overview

4.1 Front view / rear view

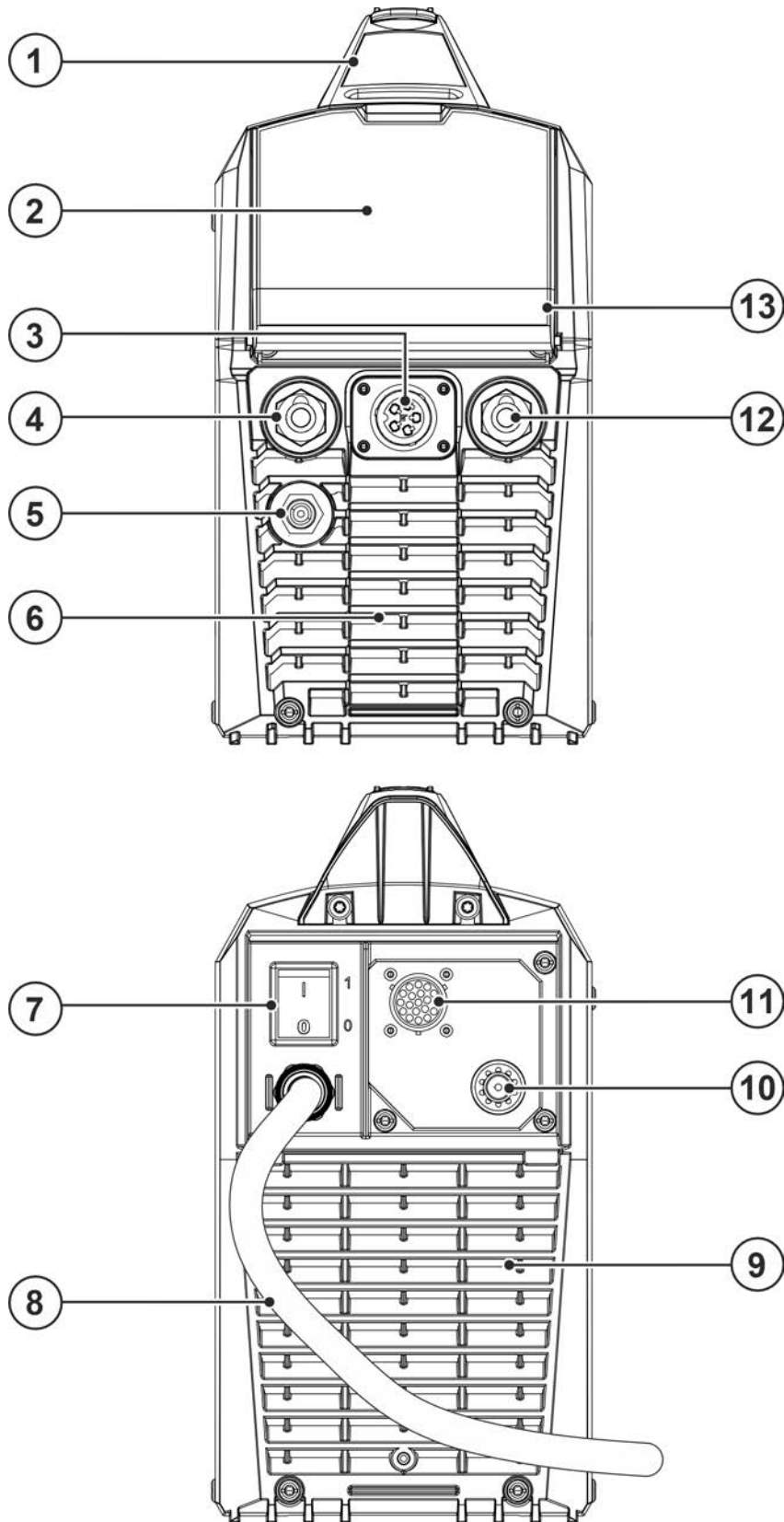







Figure 4-1

Item	Symbol	Description
1		Transport handle with additional integrated functions <ul style="list-style-type: none"> • Wear part compartment > see 5.1.9 chapter • Transport belt > see 5.1.1 chapter
2		Machine control > see 4.2 chapter
3		Connection socket - welding torch control cable > see 5.2.1.1 chapter
4		Connection socket (+) welding current How to connect the accessories depends on the welding procedure. Please observe the connection description for the corresponding welding procedure > see 5 chapter.
5		Connection thread - G$\frac{1}{4}$" Shielding gas connection (outlet)
6		Cooling air outlet
7		Main Switch Switching the machine on or off.
8		Mains connection cable > see 5.1.7 chapter
9		Cooling air inlet Dirt filter optional > see 9 chapter
10		Connection thread - G$\frac{1}{4}$" Shielding gas connection (inlet)
11		Connection socket 19-pole Remote control connection
12		Connection socket (-) welding current How to connect the accessories depends on the welding procedure. Please observe the connection description for the corresponding welding procedure > see 5 chapter.
13		Protective cap > see 5.1.8 chapter

4.2 Machine control – Operating elements

4.2.1 Overview of control sections

For description purposes, the machine control has been divided into two sections (A, B) to ensure maximum clarity. The setting ranges for the parameter values are summarised in the parameter overview section > see 10.1 chapter.



Figure 4-2

Item	Symbol	Description
1		Control section A > see 4.2.1.1 chapter
2		Control section B > see 4.2.1.2 chapter
3		Click wheel <ul style="list-style-type: none"> ----- Setting the welding power ----- Navigate through menu and parameters ----- Setting the parameter values depending on the preselection.
4		Push-button for operating modes > see 5.2.5 chapter <ul style="list-style-type: none"> H----- Non-latched HH----- Latched spotArc- Spot welding procedure spotArc spotmatic Spot welding procedure spotmatic
5		Push-button for welding procedure <ul style="list-style-type: none"> T----- TIG-welding M----- MMA welding Cel----- MMA Cel welding (characteristics for cellulose electrode)
6		Push-button for shielding gas / lock function <ul style="list-style-type: none"> ----- Shielding gas > see 5.2.2 chapter ----- Lock function > see 4.3.5 chapter

4.2.1.1 Control section A

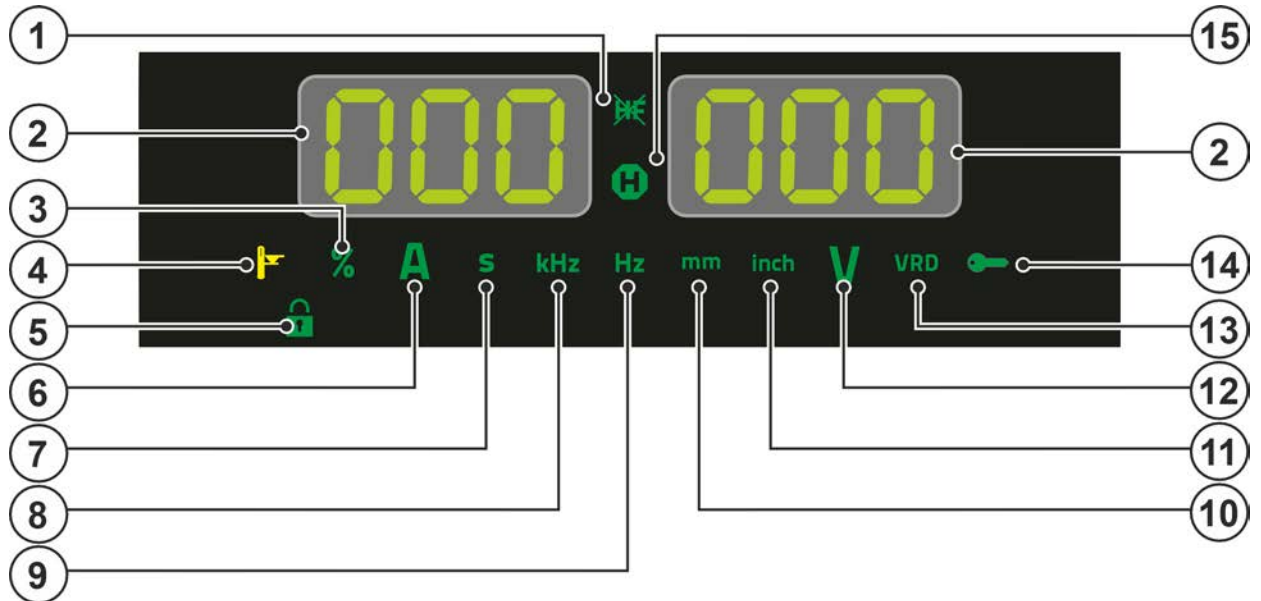

Figure 4-3

Item	Symbol	Description
1		TIG ignition type signal light Signal light on: Lift arc ignition active/HF start off. You can switch the ignition type in the Expert menu (TIG) > see 5.2.4 chapter.
2		Machine display The machine displays primarily show the welding power as a nominal value in terms of current and voltage. Other machine or welding parameters and their values are displayed depending on the current operation > see 10.1 chapter.
3		Signal light - display value in per cent
4		Excess temperature signal light In case of excess temperature, temperature monitors de-activate the power unit, and the excess temperature control lamp comes on. Once the machine has cooled down, welding can continue without any further measures.
5		Signal light for lock function > see 4.3.5 chapter
6		Welding current signal light Display of the welding current in amperes.
7		Signal light - display value in seconds
8		Signal light - display value in kilohertz
9		Signal light - display value in hertz
10		Signal light - display value in millimetres
11		Signal light - display value in inch
12		Signal light welding voltage Illuminates when the welding voltage is displayed in volts.
13		Without function in this machine version.
14		Access control active signal light Signal light is on when access control is active on the machine control > see 5.6 chapter.
15		Signal light for status display After each completed welding process, the last values used for welding current and voltage are shown in the displays and the signal light is on.

4.2.1.2 Control section B

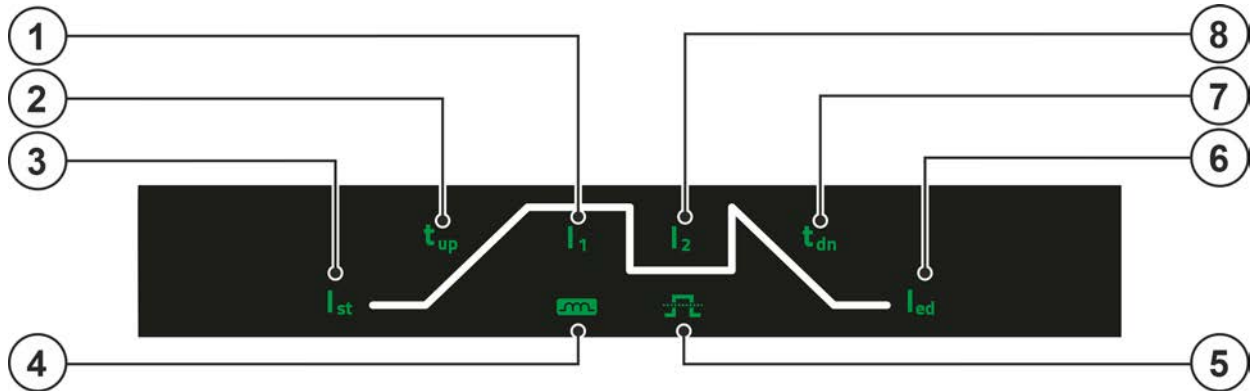

Figure 4-4

Item	Symbol	Description
1	I_1	Signal light for main current I_1
2	t_{up}	Signal light for up-slope time t_{up}
3	I_{st}	Signal light for start current I_{st}
4		Signal light for Arcforce (welding characteristics) > see 5.3.4 chapter
5		Signal light for pulse welding (TIG > see 5.2.6 chapter / MMA > see 5.3.6 chapter) is not on: Function is switched off lights up green: Average value pulsing is activated lights up red: Automatic pulsing is activated
6	I_{ed}	Signal light for end current I_{ed}
7	t_{dn}	Signal light for down-slope time t_{dn}
8	I_2	Signal light for secondary current I_2

4.3 Operating the machine control

4.3.1 Main screen

After switching on the machine or finishing a setting, the machine control changes to the main screen. This means that the previously selected settings are accepted (if necessary, indicated by signal lights) and the nominal value of the current (A) is shown in the welding data display on the left. The welding data display on the right shows the nominal value for the preselected welding voltage (V). The control changes back to the main screen after 4 s.

4.3.2 Welding parameter setting in the operation sequence

Set a welding parameter in the functional sequence by clicking (select) and turning the click wheel (navigate to the desired parameter). Press again to apply the selected parameter as the setting (the parameter value and the corresponding signal light flash). Then turn to set the parameter value.

4.3.3 Setting advanced welding parameters (Expert menu)

The Expert menu contains functions and parameters that cannot be set directly on the machine control or for which regular settings are not required. The number and display of these parameters depend on the previously selected welding procedure or functions.



To select, press and hold the click wheel (> 2 s). Select the appropriate parameter / menu item by turning (navigating) and pressing (confirming) the click wheel.

The control changes from the Expert parameters back to the main view if there is no activity (4 s). When a parameter is selected for adjustment, a long press on the click wheel or 30 seconds of inactivity will switch back to the main view.

4.3.4 Changing basic settings (machine configuration menu)

The basic welding system functions can be adjusted in the machine configuration menu. Only experienced users should change the settings > see 5.7 chapter.

4.3.5 Lock function

The lock function indicated by the signal light  protects against accidental adjustment of the machine settings. All operating elements are disabled when the feature is enabled. The welding process cannot be started when the lock is activated. Press and hold (> 2 s) the push-button  to enable or disable the function.

5 Design and function

⚠ WARNING



Risk of injury from electrical voltage!

Contact with live parts, e.g. power connections, can be fatal!

- Observe the safety information on the first pages of the operating instructions!
- Commissioning must be carried out by persons who are specifically trained in handling power sources!
- Connect connection or power cables while the machine is switched off!

Read and observe the documentation to all system and accessory components!

5.1 Transport and installation

⚠ WARNING



Risk of accident due to improper transport of machines that must not be lifted!

Do not lift or suspend the machine! The machine can drop and cause injuries! The handles, straps or brackets are suitable for transport by hand only!

- The machine must not be suspended or lifted using a crane.

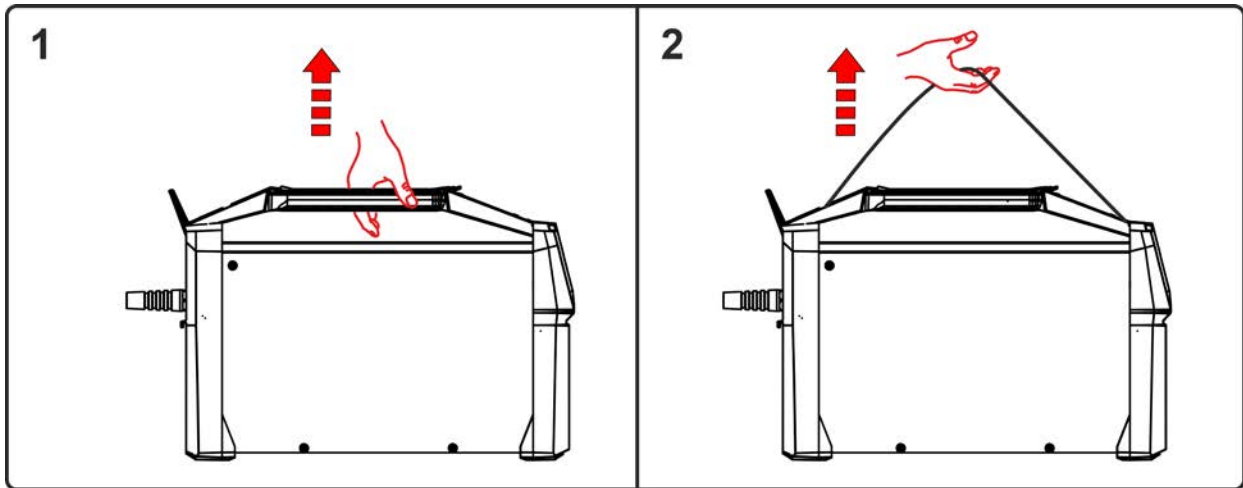

Figure 5-1

The machine can be carried either centrally on the transport handle (1) or using the transport belt (2).

5.1.1 Transport belt

5.1.1.1 Adjusting the length of the carrying strap

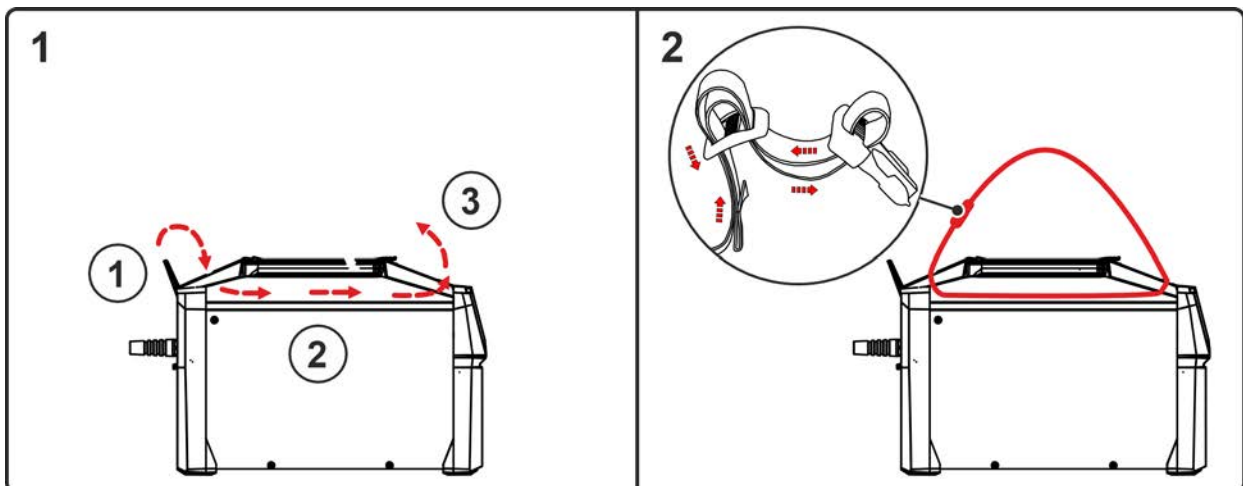



Figure 5-2

5.1.2 Ambient conditions

-  **The machine must not be operated in the open air and must only be set up and operated on a suitable, stable and level base!**
- **The operator must ensure that the ground is non-slip and level, and provide sufficient lighting for the place of work.**
 - **Safe operation of the machine must be guaranteed at all times.**

-  **Machine damage due to contamination!**
Unusually high amounts of dust, acid, corrosive gas or substances may damage the machine (note the maintenance intervals > see 6.2 chapter).
- **Prevent high amounts of smoke, weld spatter, steam, oil vapour, grinding dust and corrosive ambient air from developing!**

In operation

Temperature range of the ambient air:

- -25 °C to +40 °C (-13 °F to 104 °F)

Relative humidity:

- up to 50 % at 40 °C (104 °F)
- up to 90 % at 20 °C (68 °F)

Transport and storage

Storage in a closed room, temperature range of the ambient air:

- -30 °C to +70 °C (-22 °F to 158 °F)

Relative humidity

- up to 90 % at 20 °C (68 °F)

5.1.3 Machine cooling

-  **Insufficient ventilation results in a reduction in performance and equipment damage.**
- **Observe the ambient conditions!**
 - **Keep the cooling air inlet and outlet clear!**
 - **Observe the minimum distance of 0.5 m from obstacles!**

5.1.4 Workpiece lead, general

CAUTION



Risk of burning due to incorrect welding current connection!

If the welding current plugs (machine connections) are not locked or if the workpiece connection is contaminated (paint, corrosion), these connections and leads can heat up and cause burns when touched!

- Check welding current connections on a daily basis and lock by turning to the right when necessary.
- Clean workpiece connection thoroughly and secure properly. Do not use structural parts of the workpiece as welding current return lead!

5.1.5 Dirt filter

These accessory components can be retrofitted as an option > see 9 chapter.

When using a dirt filter, the cooling air throughput is reduced and the duty cycle of the machine is reduced as a result. The duty cycle decreases with the increasing contamination of the filter. The dirt filter must be removed at regular intervals and cleaned by blowing out with compressed air (depending on the level of soiling).

5.1.6 Notes on the installation of welding current leads

- Use an individual welding lead to the workpiece for each welding machine!

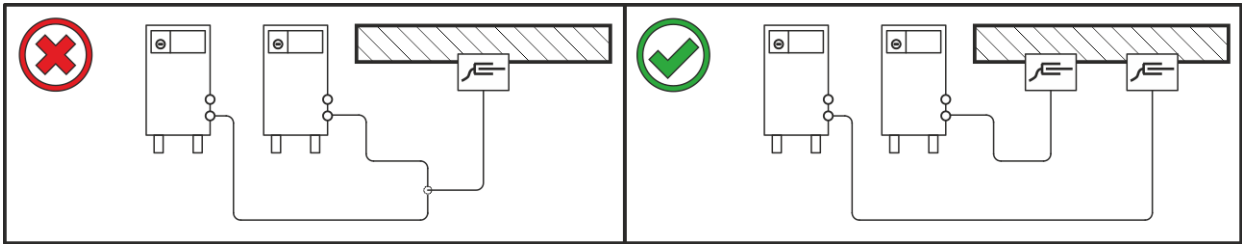

Figure 5-3

- Fully unroll welding current leads, torch hose packages and intermediate hose packages. Avoid loops!
- Always keep leads as short as possible!

Lay any excess cable lengths in meanders.

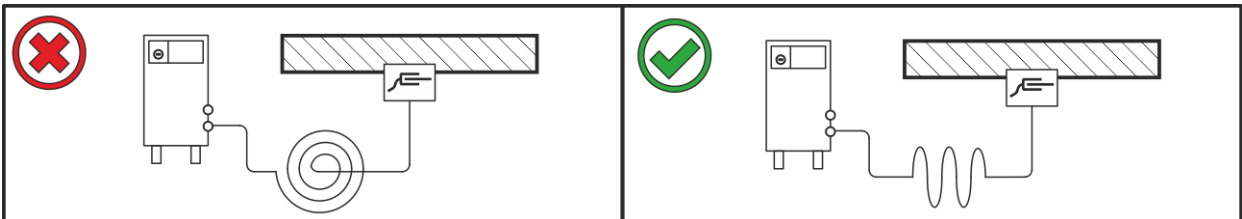

Figure 5-4

5.1.7 Mains connection

DANGER



Hazards caused by improper mains connection!

An improper mains connection can cause injuries or damage property!

- The connection (mains plug or cable), the repair or voltage adjustment of the device must be carried out by a qualified electrician in accordance with the respective local laws or national regulations!
- The mains voltage indicated on the rating plate must match the supply voltage.
- Only operate machine using a socket that has correctly fitted protective earth.
- Mains plug, socket and lead must be checked by a qualified electrician on a regular basis!
- When operating the generator, always ensure it is earthed as stipulated in the operating instructions. The network created must be suitable for operating machines according to protection class I.



To operate with a 120 V mains supply voltage, the standard mains plug must be removed and replaced with a suitable mains plug by a qualified electrician > see 8.1.2 chapter.

5.1.7.1 Mains configuration

-  **The machine may only be connected to a one-phase system with two conductors and an earthed neutral conductor.**

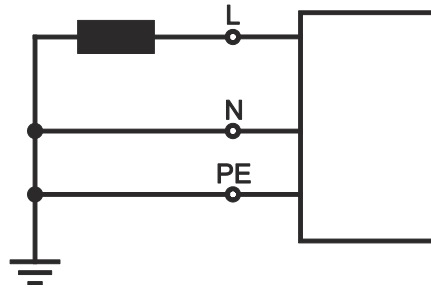

Figure 5-5

Legend

Item	Designation	Colour code
L	Outer conductor	brown
N	Neutral conductor	blue
PE	Protective conductor	green-yellow

- Insert mains plug of the switched-off machine into the appropriate socket.

5.1.8 Protective flap, welding machine control

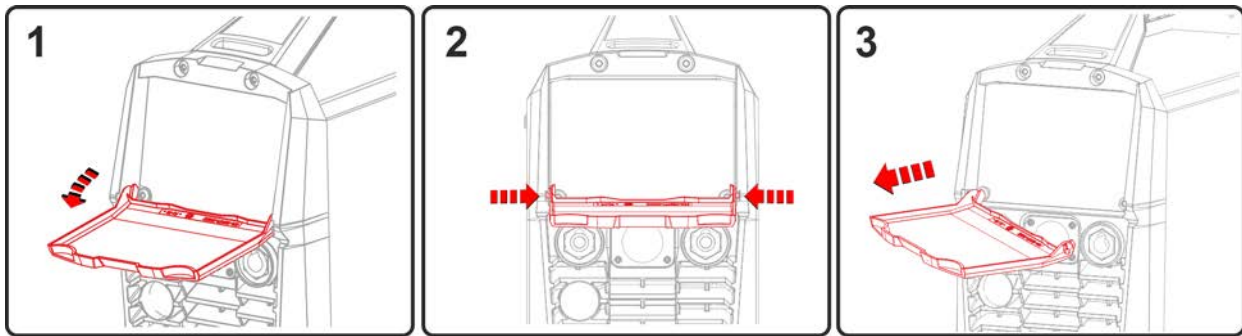

Figure 5-6

- Open the protective cap.
- Apply slight pressure to the left and/or right connecting bridge (illustration) until the protective cap can be removed.

5.1.9 Wear part compartment

The transport handle of this machine series holds a wear parts compartment for storing typical small wear parts. The compartment is closed with a plastic flap.

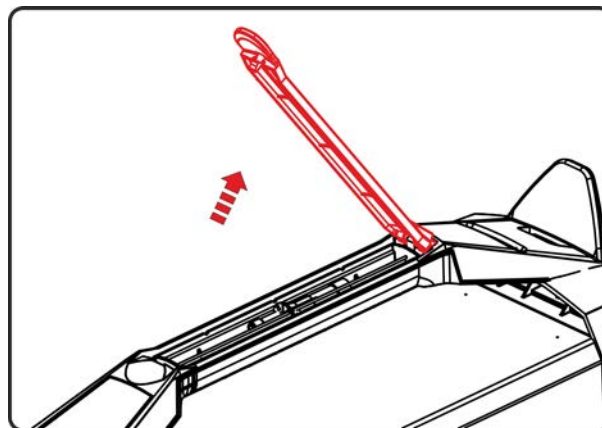

Figure 5-7

5.2 TIG welding

5.2.1 Welding torch and workpiece line connection

Prepare welding torch according to the welding task in hand (see operating instructions for the torch).

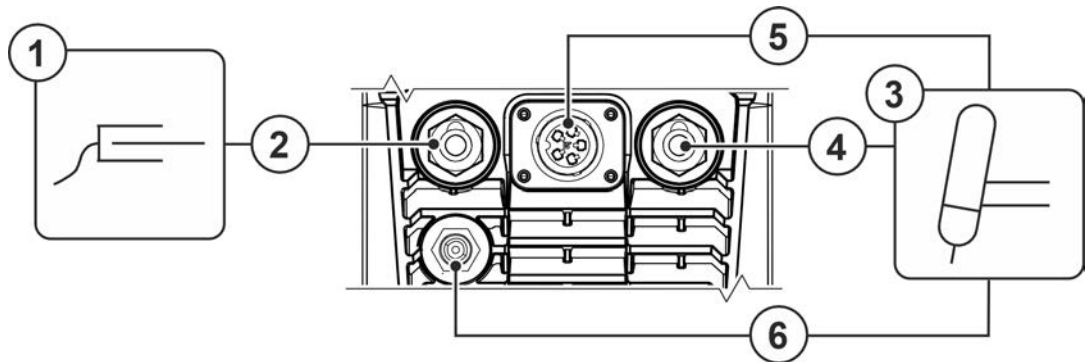

Figure 5-8

Item	Symbol	Description
1		Workpiece
2		Connection socket for (+) welding current Workpiece lead connection
3		Welding torch
4		(-) Welding current connection socket TIG welding torch welding current lead connection.
5		Welding torch control cable > see 5.2.1.1 chapter
6		Shielding gas hose

- Insert the cable plug on the work piece lead into the "+" welding current connection socket and lock by turning to the right.
- Insert the welding current plug on the welding torch into the welding current connection socket and lock by turning to the right.
- Remove yellow protective cap on G $\frac{1}{4}$ " connecting nipple.
- Screw welding torch shielding gas connection tightly onto the G $\frac{1}{4}$ " connection nipple.
- Plug the welding torch control cable plug into the welding torch control cable connection socket and secure.

5.2.1.1 Control lead connection

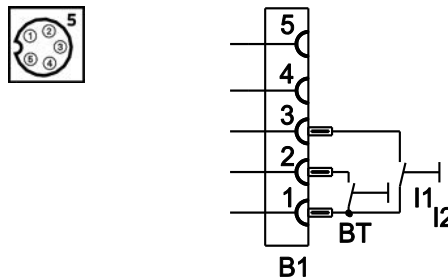

Figure 5-9

5.2.2 Shielding gas supply (shielding gas cylinder for welding machine)

⚠ WARNING



Risk of injury due to improper handling of shielding gas cylinders!
Improper handling and insufficient securing of shielding gas cylinders can cause serious injuries!

- Observe the instructions from the gas manufacturer and any relevant regulations concerning the use of compressed air!
- Do not attach any element to the shielding gas cylinder valve!
- Prevent the shielding gas cylinder from heating up.



An unhindered shielding gas supply from the shielding gas cylinder to the welding torch is a fundamental requirement for optimum welding results. In addition, a blocked shielding gas supply may result in the welding torch being destroyed.

- **Always re-fit the yellow protective cap when not using the shielding gas connection.**
- **All shielding gas connections must be gas tight.**

5.2.2.1 Pressure regulator connection

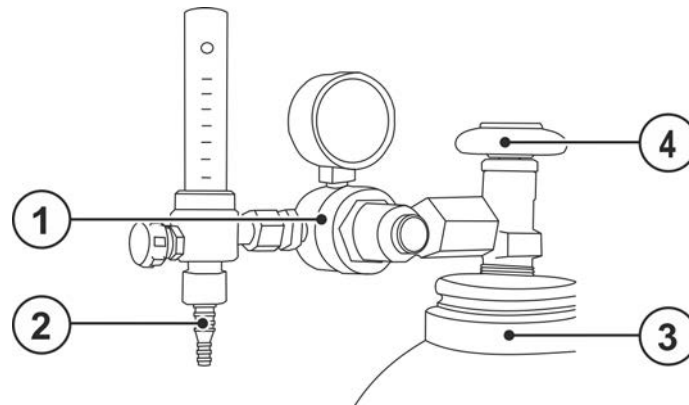

Figure 5-10

Item	Symbol	Description
1		Pressure regulator
2		Output side of the pressure regulator
3		Shielding gas cylinder
4		Cylinder valve

- Before connecting the pressure regulator to the gas cylinder, open the cylinder valve briefly to blow out any dirt.
- Tighten the pressure regulator screw connection on the gas bottle valve to be gas-tight.
- Screw the gas hose connection to the outlet side of the pressure regulator gas-tight.

5.2.2.2 Shielding gas hose connection

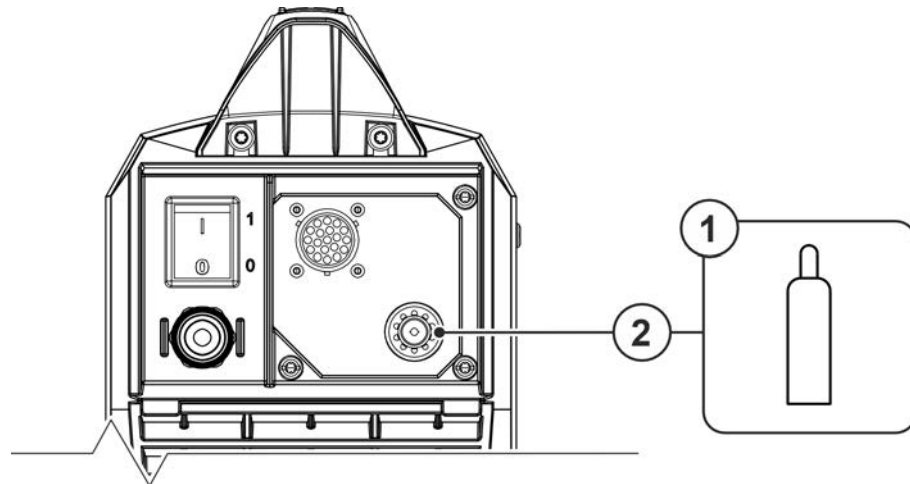

Figure 5-11

Item	Symbol	Description
1		Shielding gas cylinder
2		Connection thread - G 1/4" Shielding gas connection (inlet)

- Screw the gas hose connection nipple onto the G 1/4" connection nipple.

5.2.2.3 Setting the shielding gas volume (gas test)/rinse hose package

- Slowly open the gas cylinder valve.
- Open the pressure regulator.
- Switch on the power source at the main switch.
- Set the relevant gas quantity for the application on the pressure regulator.
- The gas test can be activated at the machine control by pressing the Gas test push-button > see 4.2 chapter.

Setting the shielding gas quantity (gas test)

- Shielding gas flows for 20 s or until the push-button is pressed again.

If the shielding gas setting is too low or too high, this can introduce air to the weld pool and may cause pores to form. Adjust the shielding gas quantity to suit the welding task!

Setting instructions: The gas nozzle diameter in mm corresponds to the gas flow in l/min.

Helium-rich gas mixtures require a higher gas volume!

The table below can be used to correct the gas volume calculated where necessary:

Shielding gas	Factor
75% Ar/25% He	1.14
50% Ar/50% He	1.35
25% Ar/75% He	1.75
100% He	3.16

5.2.2.4 Automatic gas post-flow

When the function is enabled, the machine control adjusts the gas post-flow time depending on the output. The adjustable gas post-flow time relates to the maximum possible current of the power source and decreases linearly.

The automatic gas post-flow function can be enabled or disabled in the machine configuration menu > see 5.7 chapter. With the function enabled, the parameters and for automatic are displayed alternately when the gas post-flow time is selected.

5.2.3 Setting welding procedure

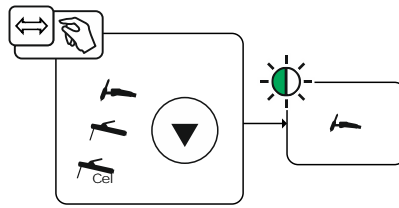

Figure 5-12

5.2.3.1 Basic setting (tungsten electrode diameter)

Setting the tungsten electrode diameter `[ndA]` presets the ignition energy and minimum current limit optimally. Smaller electrode diameters require less ignition energy than larger electrode diameters.

With the selection of the electrode diameter, a minimum current limit is set that in turn affects the start, main and secondary currents. Minimum current limits prevent an unstable arc at low currents. If necessary, the minimum current limits can be disabled with the parameter `[cLI]` in the machine configuration menu > see 5.7 chapter. When using a foot-operated remote control, the minimum current limits are disabled by default.

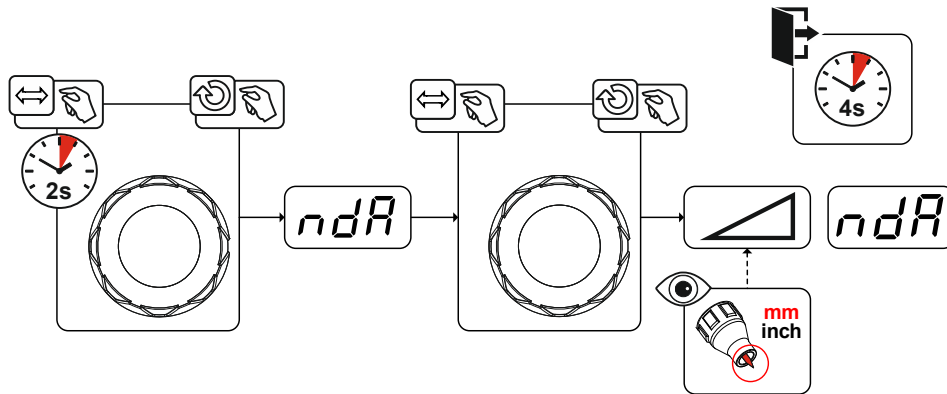

Figure 5-13

5.2.4 Arc ignition

5.2.4.1 HF ignition

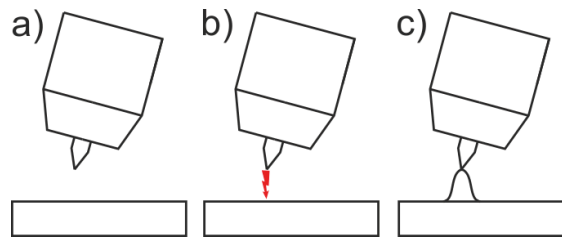

Figure 5-14

The arc is started without contact using high-voltage ignition pulses:

- Position the welding torch in the welding position above the workpiece (distance between the electrode tip and the workpiece approx. 2-3 mm).
- Press the torch trigger (high-voltage ignition pulses start the arc).
- Depending on the selected operating mode, the welding current flows with the set start or main current.

Ending the welding process: Release the torch trigger or press and release depending on the selected operating mode.

5.2.4.2 Liftarc

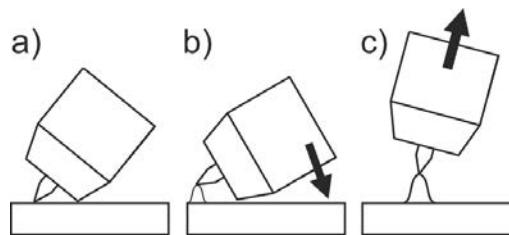

Figure 5-15

The arc is ignited on contact with the workpiece:

- Carefully place the torch gas nozzle and tungsten electrode tip onto the workpiece and press the torch trigger (liftarc current flowing, regardless of the main current set).
- Incline the torch over the torch gas nozzle to produce a gap of approx. 2-3 mm between the electrode tip and the workpiece. The arc ignites and the welding current is increased, depending on the operating mode set, to the ignition or main current set.
- Lift off the torch and swivel to the normal position.

Ending the welding process: Release or press the torch trigger depending on the operating mode selected.



5.2.4.3 Automatic cut-out

The automatic cut-out triggered by two states ends the welding process after the error times have elapsed:

- During ignition
3 s after the start of the welding process, no welding current flows (ignition error).
- During welding
The arc is interrupted for more than 5 s (arc interruption). You can disable or set the time for re-ignition after an arc interruption in the machine configuration menu > see 5.7 chapter (parameter I_{LR}).

5.2.5 Operating modes (functional sequences)

5.2.5.1 Explanation of symbols

Symbol	Meaning
	Press torch trigger 1
	Release torch trigger 1
I	Current
t	Time
\overline{GPr}	Gas pre-flow
$\overline{I_{St}}$	Start current
$\overline{t_{St}}$	Start time
$\overline{t_{UP}}$	Up-slope time
$\overline{t_P}$	Spot time
$\overline{I_1}$	Main current (minimum to maximum current)
$\overline{I_2}$	Secondary current
$\overline{I_{PL}}$	Pulse current (average value pulsing)
$\overline{b_{RL}}$	Balance (average value pulsing)
\overline{FrE}	Frequency (average value pulsing)
$\overline{t_{S1}}$	Slope time from main current to secondary current
$\overline{t_{S2}}$	Slope time from secondary current to main current
$\overline{t_{dn}}$	Down-slope time
$\overline{I_{Ed}}$	End current
$\overline{t_{Ed}}$	End current time
\overline{GPE}	Gas post-flow

5.2.5.2 Non-latched mode Sequence

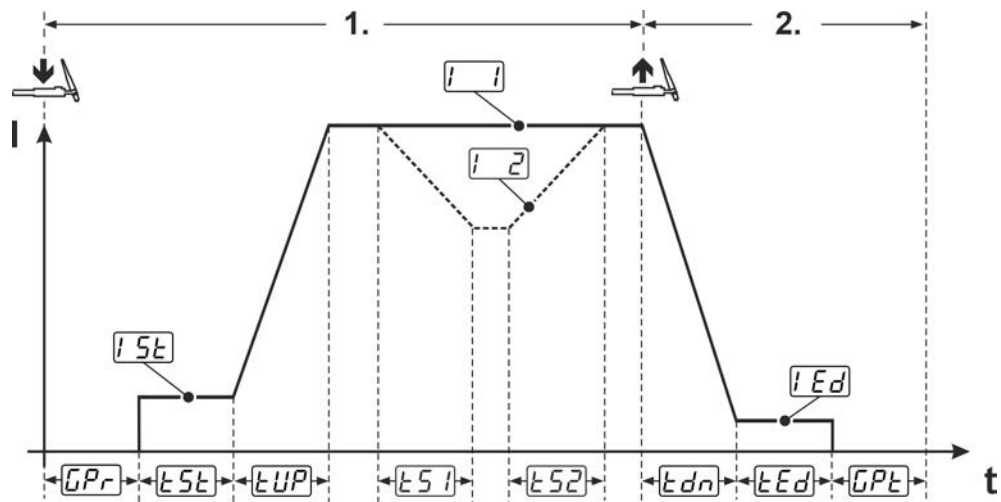

Figure 5-16

1st cycle:

- Press and hold torch trigger 1.
- The gas pre-flow time t_{Pr} expires (shielding gas flows).
- The arc is ignited (HF ignition).
- The start current I_{St} flows for the start time t_{St} .
- The welding current increases in the up-slope time t_{Up} to the main current I_1 .

2nd cycle:

- Release torch trigger 1.
- The main current I_1 drops during the down-slope time t_{dn} to the end current I_{Ed} .
When the 1st torch trigger is pressed during the down-slope time t_{dn} , the current increases again to the main current I_1 .
- The end current I_{Ed} flows for the end current time t_{Ed} .
- The arc extinguishes.
- The gas post-flow time t_{PE} expires (the shielding gas is shut down).

Secondary current I_2

In each current phase, you can switch to the secondary current I_2 using the slope times t_{S1} and t_{S2} . The slope times can be set in the Expert menu > see 5.2.9 chapter.

Two options for switching to secondary current:

- Hold torch trigger 2.
- Tap the torch trigger 1 (only during the down-slope and end current phase with the tap end function switched off t_{PE}).

5.2.5.3 Latched mode

Sequence

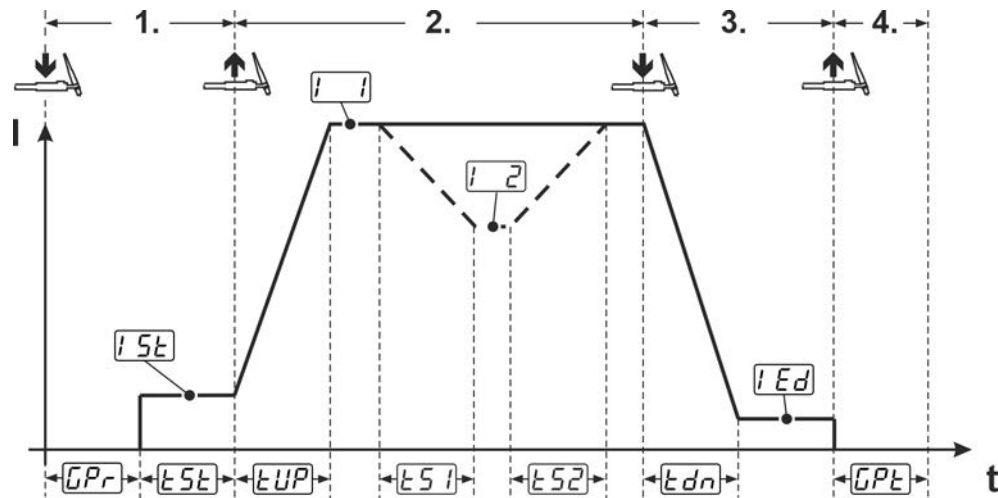

Figure 5-17

1st cycle

- Press the torch trigger 1
- The gas pre-flow time GPr expires (shielding gas flows).
- The arc is ignited (HF ignition).
- The start current iSt flows as long as the torch trigger is held, but at least for the start time tSt .

2nd cycle

- Release torch trigger 1.
- The welding current increases in the up-slope time tUp to the main current $i1$.

3rd cycle

- Press torch trigger 1.
- The main current $i1$ drops during the down-slope time tDn to the end current iEd .

4th cycle

- Release torch trigger 1.
- The arc extinguishes.
- The gas post-flow time GPE expires (the shielding gas is shut down).

Secondary current $i2$

In each current phase, you can switch to the secondary current $i2$ using the slope times $tS1$ and $tS2$. The slope times can be set in the Expert menu > see 5.2.9 chapter.

Two options for switching to secondary current:

- Hold torch trigger 2.
- Tap torch trigger 1.

Alternative welding start (tap start):

The tap start function tPS must be switched on before using it. With the alternative welding start, the duration of the first and second cycle is only specified by the set process times (tapping the torch trigger in the gas pre-low phase GPr).

Alternative welding end (tap end):

With the alternative welding end, the process is ended immediately by tapping the torch trigger in the main-current phase (gas post-flow time expires).

The tap end function tPE must be switched on before using it (this disables tapping on the secondary current).

5.2.5.4 spotArc

This process is suitable for tack welding or joint welding of metal sheets made from steel and CrNi alloys up to a thickness of approximately 2.5 mm. Metal sheets of different thicknesses can also be welded on top of one another. As this is a one-sided process, it is also possible to weld metal sheets onto tubular sections such as round or square pipes. In arc spot welding, the arc melts through the upper metal sheet and the lower metal sheet is melted onto it. This produces flat, fine-textured welding tacks which require little or no post weld work, even in visible areas.

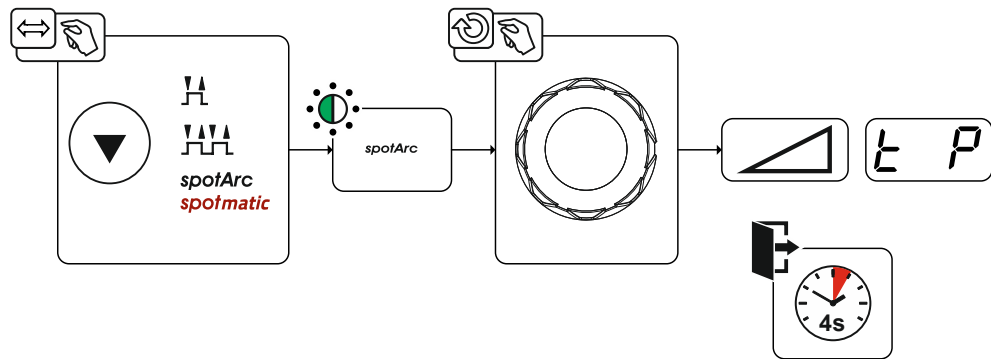

Figure 5-18

With the spotArc function enabled, automated pulsing is activated as well. If required, pulse welding can also be deactivated using the parameter PUL or switched between the pulse variants average value pulsing or automated pulsing.

To achieve an effective result, the slope times t_{UP} and t_{dn} are deactivated after the function spotArc has been activated. If required, the slope times can also be activated and displayed using the parameter SLD in this operating mode.

Example display with factory settings of the parameters:

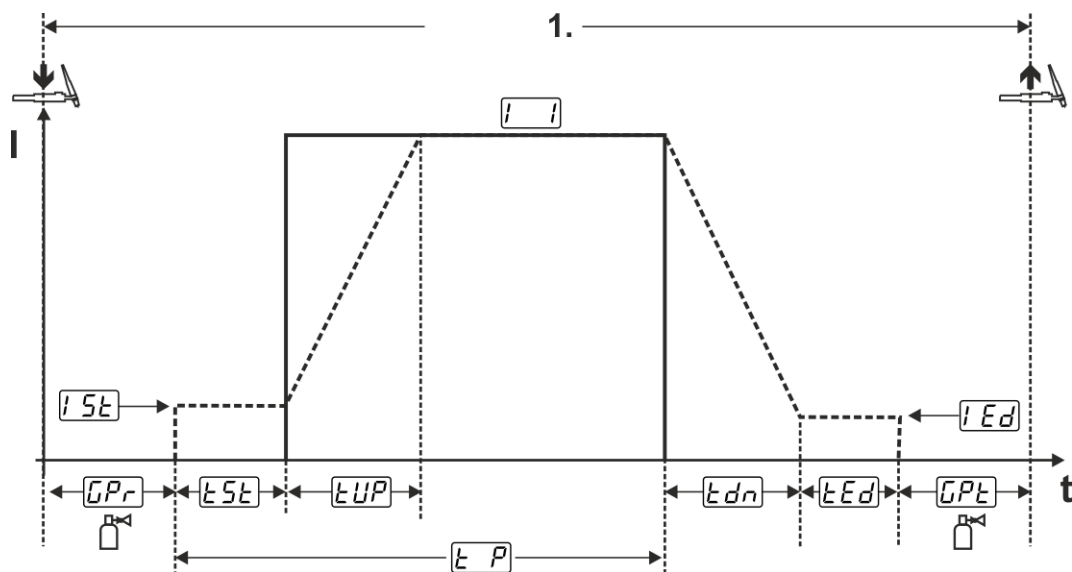

Figure 5-19

Procedure:

- Press and hold the torch trigger.
- The gas pre-flow time elapses.
- The HF ignition pulses jump from the electrode to the workpiece. The arc ignites.
- HF switches off.
- The welding current flows and immediately assumes the value of the start current I_{SE} .
- The start current I_{SE} flows for the ignition current time t_{SE} .
- The welding current ramps up to the main current t_{UP} within the set up-slope time t_{UP} .
- The process ends when the set spotArc time t_P expires or by releasing the torch trigger prematurely.

5.2.5.5 spotmatic

In contrast to the spotArc operating mode, the arc is not started by pressing the torch trigger as in the conventional method, but by briefly placing the tungsten electrode $\overline{[P7]}$ on the workpiece. The torch trigger is used to enable the welding process. The activation is indicated by flashing of the spotArc@/spotmatic signal light. The separate process activation $\overline{[5P]}$ and the short setting range $\overline{[55]}$ of the spot time $\overline{[P]}$ are activated by default with spotmatic.

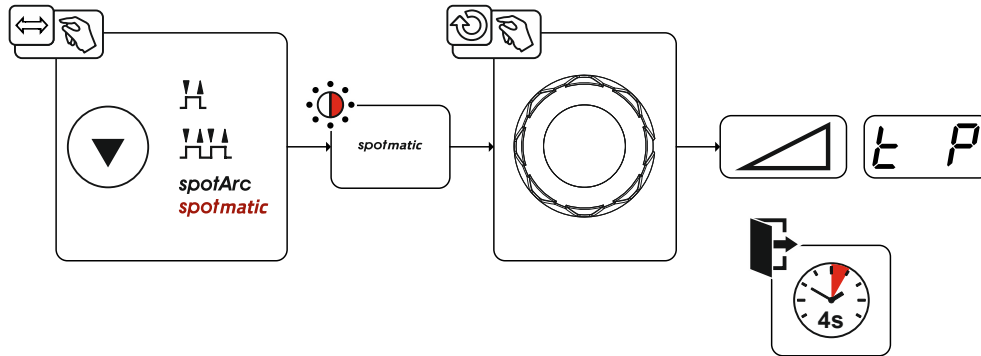

Figure 5-20

Example display with factory settings of the parameters:

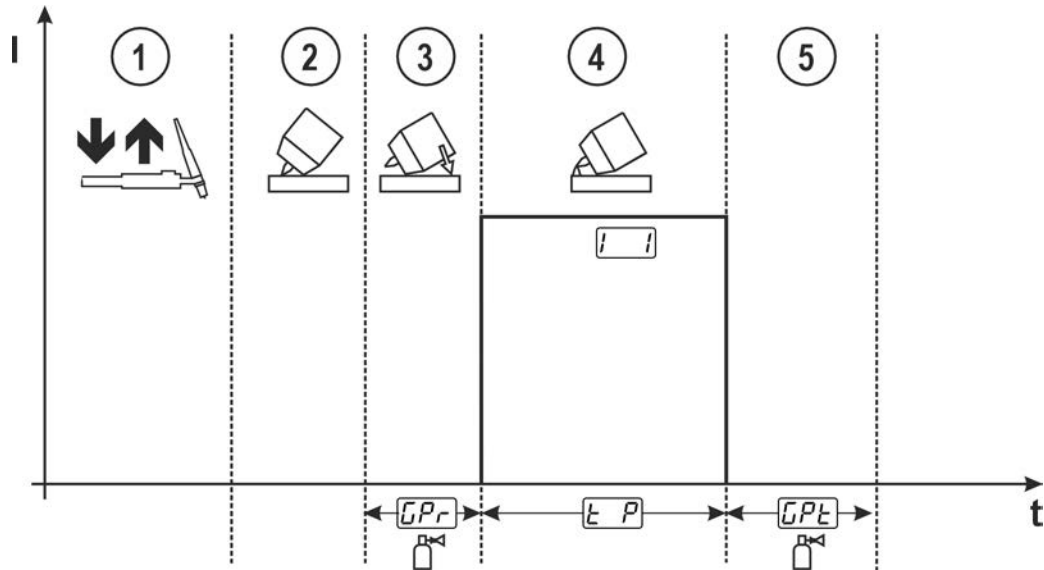

Figure 5-21

- ① Tap the torch trigger to activate the welding process.
- ② Place the torch gas nozzle and tungsten electrode tip carefully on the workpiece.
- ③ Incline the welding torch over the torch gas nozzle until there is a gap of approx. 2-3 mm between the electrode tip and the workpiece. Shielding gas flows with the set gas pre-flow time \overline{GPr} . The arc ignites and the previously set main current \overline{I} flows.
- ④ The main current phase \overline{I} ends when the set spot time \overline{EP} elapses.
- ⑤ The gas post-flow time \overline{GPE} elapses and the welding process ends.

The following parameter settings can be adjusted in the machine configuration menu > see 5.7 chapter.

- Separate process activation ($\overline{SSP} > \overline{on}$):
The welding process must be re-enabled before each arc striking by tapping the torch trigger. Process activation is automatically terminated after 30 s of inactivity.
- Permanent process activation ($\overline{SSP} > \overline{OFF}$):
The welding process is enabled by tapping the torch trigger once. The following arc striking processes are initiated by briefly placing the tungsten electrode on the workpiece. Process activation is terminated either by tapping the torch trigger again or automatically after 30 s of inactivity.
- Process start by placing the tungsten electrode on the workpiece ($\overline{SP\eta} > \overline{on}$).
- Process start by tapping the torch trigger ($\overline{SP\eta} > \overline{OFF}$).
- Short setting range of spot time ($\overline{SES} > \overline{on}$).
- Long setting range of spot time ($\overline{SES} > \overline{OFF}$).
In this case, the procedure is the same as for spotArc.

5.2.6 Pulse welding

5.2.6.1 Average value pulse welding

A special feature with average value pulses is that the power source will always maintain the preset average value. This makes this method especially suitable for welding according to welding procedure specifications.

For average value pulsing ($\overline{R_{UG}}$), switching takes place periodically between two currents whereby an average current value (i), a pulse current (i_{PL}), pulse balance (b_{RL}) and pulse frequency (f_{rE}) must be specified. The set average current value in amperes is decisive. The pulse current is specified as a percentage of the average value current.

The pulse pause current (IPP) is not set. This value is calculated by the machine control to ensure that the average value of the welding current is maintained.

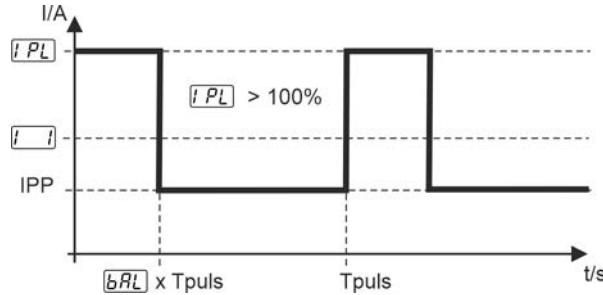

Figure 5-22

Setting the pulse current, pulse frequency and pulse balance

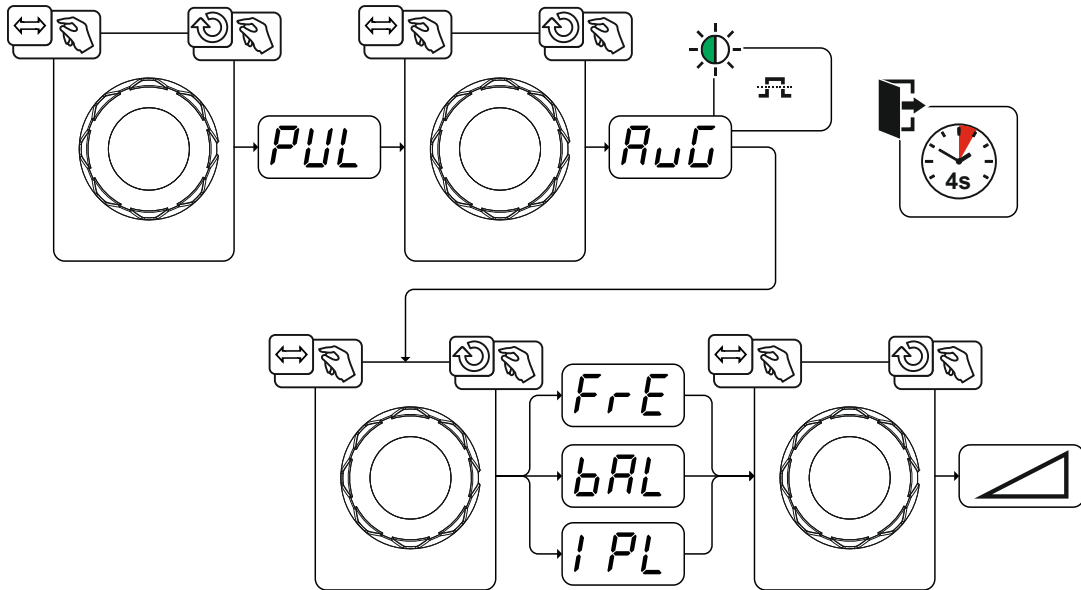

Figure 5-23

5.2.6.2 Automated pulses

The current-dependent pulse frequency and balance create vibrations in the weld pool that have a positive effect on the gap bridging. The machine control specifies the required pulse parameters automatically.

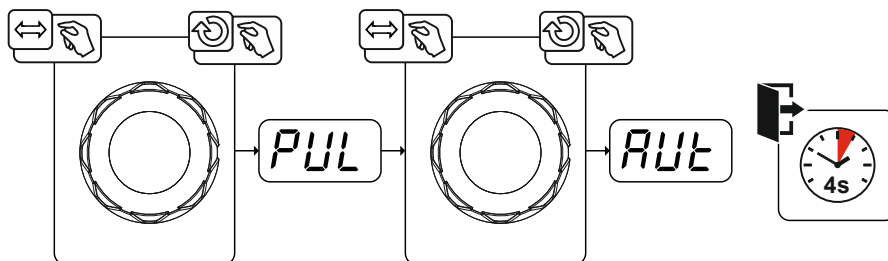

Figure 5-24

5.2.7 Welding torch (operating variants)

5.2.7.1 Welding torch mode

The operating elements (torch triggers or rockers) and their function can be individually adjusted using different torch modes. Up to four modes are available to the user. The tables for the corresponding torch types describe the functional options.

Explanation of symbols for welding torch:

Symbol	Description
	Press torch trigger
	Tap torch trigger
	Tap torch trigger and then press
BRT 1, 2	Torch trigger 1 or 2
UP	Torch trigger UP - increase the value
DOWN	Torch trigger DOWN - decrease the value

The torch modes are set using the torch configuration parameters " $\overline{[ErD]}$ " in the machine configuration menu > torch mode " $\overline{[ErD]}$ " > see 5.7 chapter.

Only the modes listed are suitable for the corresponding torch types.

Welding torch with one torch trigger

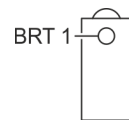

Figure 5-25

Function	Operation	Mode
Welding current On / Off	BRT 1	1
Secondary current		

Welding torch with two torch triggers or rocker



Figure 5-26

Function	Operation	Mode
Welding current On / Off	BRT 1	1
Secondary current		
Secondary current		
Secondary current	BRT 2	
Welding current On / Off	BRT 1 + 2	2
Secondary current		
Increase welding current (up/down speed)	BRT 1	
Decrease welding current (up/down speed)	BRT 2	
Welding current On / Off	BRT 1	3
Secondary current		
Increase welding current (up/down speed)	BRT 2	
Decrease welding current (up/down speed)		

TIG function torch, Retox XQ

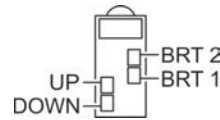

Figure 5-27

Function	Operation		Mode
Welding current On / Off	BRT 1	↓	1
Secondary current		↕	
Secondary current	BRT 2	↓	
Increase welding current (up/down speed)	UP	↓	
Decrease welding current (up/down speed)	DOWN	↓	
Welding current On / Off	BRT 1	↓	
Secondary current		↕	
Secondary current	BRT 2	↓	
Increase welding current in steps (current jump)	UP	↓	
Decrease welding current in steps (current jump)	DOWN	↓	

5.2.7.2 Tapping function (tap torch trigger)

Tapping function: Swiftly tap the torch trigger to change the function. The set torch mode determines the operating mode.

The tapping function can be selected separately for each torch mode for the start of welding with parameter $[EPS]$ and for the end of welding with parameter $[PEE]$. If parameter $[PEE]$ is activated, there is no need to tap the secondary current.

5.2.7.3 Up/down speed

Functionality

Press and hold the up push-button:

Increase current up to the maximum value (main current) set in the power source.

Press and hold the down push-button:

Decrease current to the minimum value.

Use the machine configuration menu > see 5.7 chapter to set the up/down speed parameter $[U/D]$ which determines the speed with which a current change becomes effective.

5.2.7.4 Current jump

By tapping the corresponding torch trigger the welding current can be determined in an adjustable jump range. Each tap will cause the welding current to jump up or down by the defined value.

The "current jump" parameter $[dI]$ is set in the machine configuration menu > see 5.7 chapter.

5.2.8 RTF 1 foot-operated remote control

The remote control allows the continuous adjustment of the welding current (0% to 100%) depending on the preselected main current $[I]$ on the welding machine.

Further individual parameter settings affect the remote control behaviour:

- Switching between linear and logarithmic responses $[FRL]$.
- Start program $[SFR]$ to optimise the arc stability.
- Start/stop operation $[FLO]$ to start and end the welding process without setting the current using the remote control.

5.2.8.1 Response

This function controls the responsiveness of the welding current during the main current phase. The user can choose between linear and logarithmic responsiveness. The logarithmic setting is particularly suitable for welding with low current, e.g., for thin panels as the logarithmic responsiveness enables better control of the welding current.

The responsiveness function can be switched in the machine configuration menu between the parameters for linear and logarithmic responsiveness (factory set) > see 5.7 chapter.

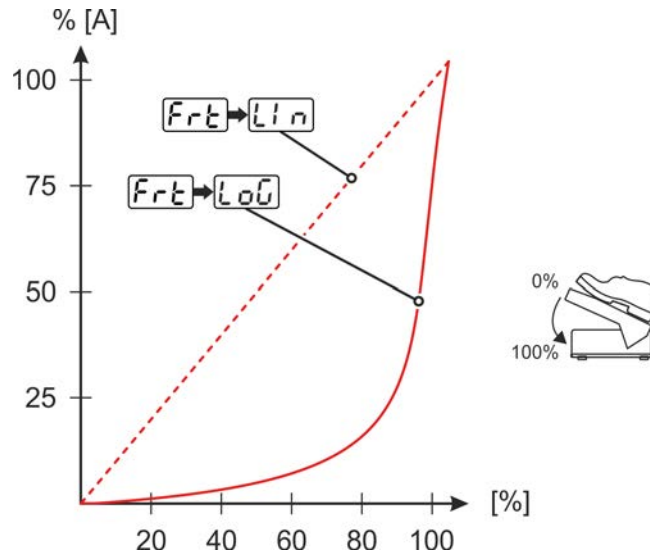

Figure 5-28

5.2.8.2 Start program

The start program “ $\overline{SF_r}$ ” can be enabled or disabled in the machine configuration menu > see 5.7 chapter.

Enabled start program

At the start of the process, the start program ensures the necessary arc stability until the main current “ $\overline{I_1}$ ” is reached. The start current “ $\overline{I_{St}}$ ”, the ignition current time “ $\overline{t_{St}}$ ” and the ramp “ $\overline{t_{UP}}$ ” can be adjusted individually according to the welding task. In the main program, the welding current can be freely regulated using the foot-operated remote control (factory setting).

Disabled start program

Without the start program, the current jumps immediately to the main current (according to the specification of the foot-operated remote control). The start current “ $\overline{I_{St}}$ ” can be used for arc stabilisation. In this case, the operation with the foot-operated remote control is only enabled when the start current is exceeded. Until then, the welding current corresponds to the start current “ $\overline{I_{St}}$ ”.

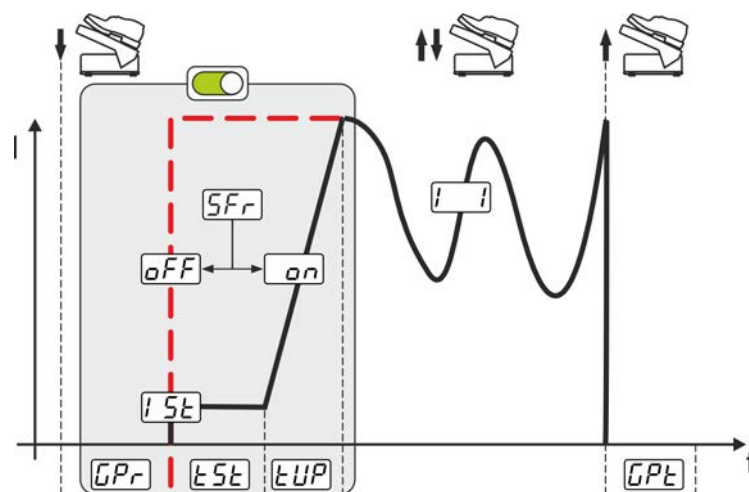

Figure 5-29

5.2.8.3 Start/stop operation

Start/stop operation “ F_{Ed} ” can be enabled or disabled in the machine configuration menu > see 5.7 chapter.

Enabled start/stop operation

The foot-operated remote control is no longer used to specify the welding current, but rather starts or ends the welding process (see torch trigger). As in normal operation, the welding current is specified using the power source control or the welding torch with the up/down function. All operating modes (non-latched, latched, etc.) can be selected.

Disabled start/stop operation

The welding current is specified using the foot-operated remote control. In this setting, only the non-latched operating mode is possible. (factory setting).

5.2.9 Expert menu (TIG)

The Expert menu has adjustable parameters stored that don't require regular setting. The number of parameters shown may be limited, e.g. if a function is deactivated.

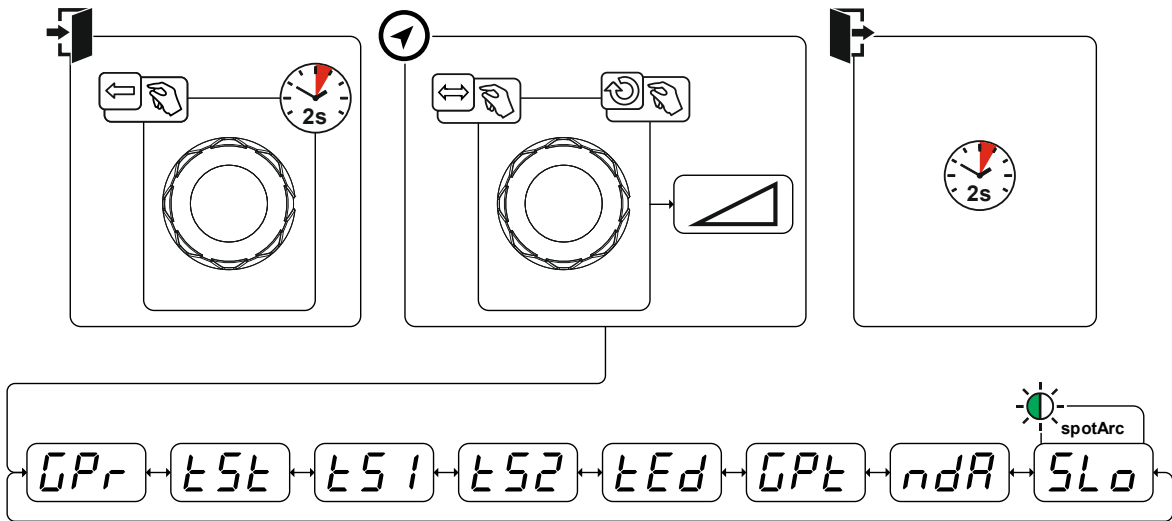

Figure 5-30

Display	Setting/selection
GPr	Gas pre-flow time
tSt	Start time (duration of start current)
$tS1$	Slope time (main current to secondary current)
$tS2$	Slope time (secondary current to main current)
tEd	End current time (duration of end current)
GPl	Gas post-flow time
ndA	Diameter of tungsten electrode / ignition optimisation
$SL0$	Slope times (spotArc/spotmatic) Slope times (t_{up} $[EUP]$ and t_{dn} $[Edn]$) in operating modes spotArc and spotmatic (long spot time) $[on]$ ----- Slope times are activated. $[off]$ ----- Slope times are deactivated (hidden).

5.3 MMA welding

5.3.1 Connecting the electrode holder and workpiece lead

⚠ CAUTION

Risk of crushing and burns!
When changing stick electrodes there is a risk of crushing and burns!

- Wear appropriate and dry protective gloves.
- Use an insulated pair of tongs to remove the used stick electrode or to move welded workpieces.

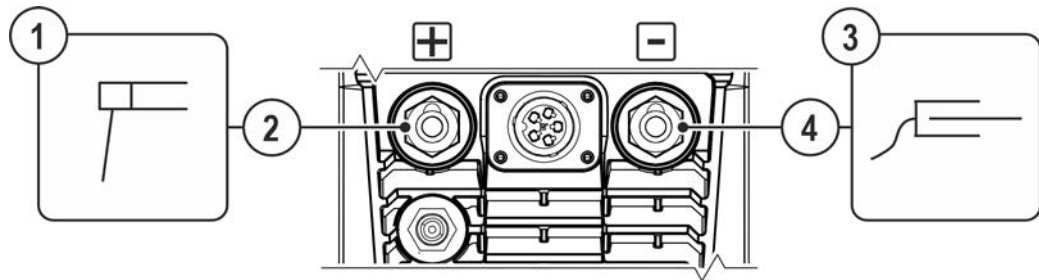

Figure 5-31

Item	Symbol	Description
1		Electrode holder
2		Welding current lead
3		Workpiece
4		Workpiece lead

- Insert the electrode holder plug and workpiece lead into the welding current socket depending on application and lock in place by turning to the right. The corresponding polarity will be based on the information of the electrode manufacturer on the electrode packaging.

5.3.2 Setting welding procedure

The following welding task selection is an example of use. In general, the selection process always has the same sequence. Signal lights (LED) will show the selected combination.

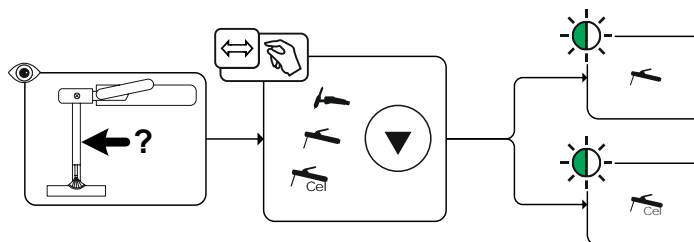

Figure 5-32

5.3.3 Hotstart

The function hot start ensures a secure igniting of the arc and a sufficient heating to the still cold parent metal at the beginning of the welding process. The ignition takes place here with increased current (hot start current) over a certain time (hot start time).

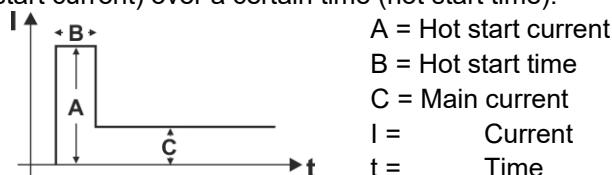

Figure 5-33

5.3.3.1 Hotstart current

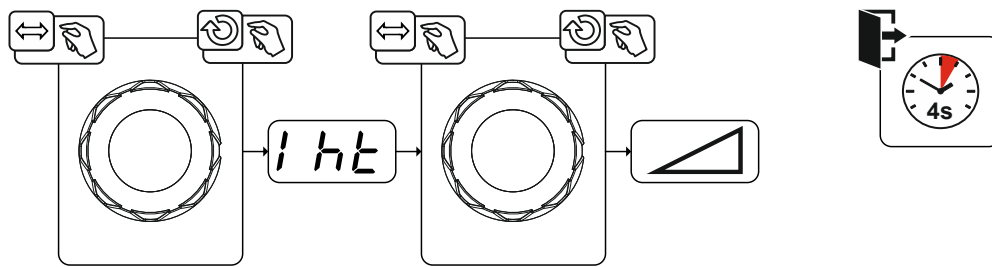

Figure 5-34

5.3.3.2 Hotstart time

The hot start times can be set in the Expert menu > see 5.3.8 chapter.

5.3.4 Arcforce

During the welding process, arcforce prevents the electrode sticking in the weld pool with increases in current. This makes it easier to weld large-drop melting electrode types at low current strengths with a short arc in particular.

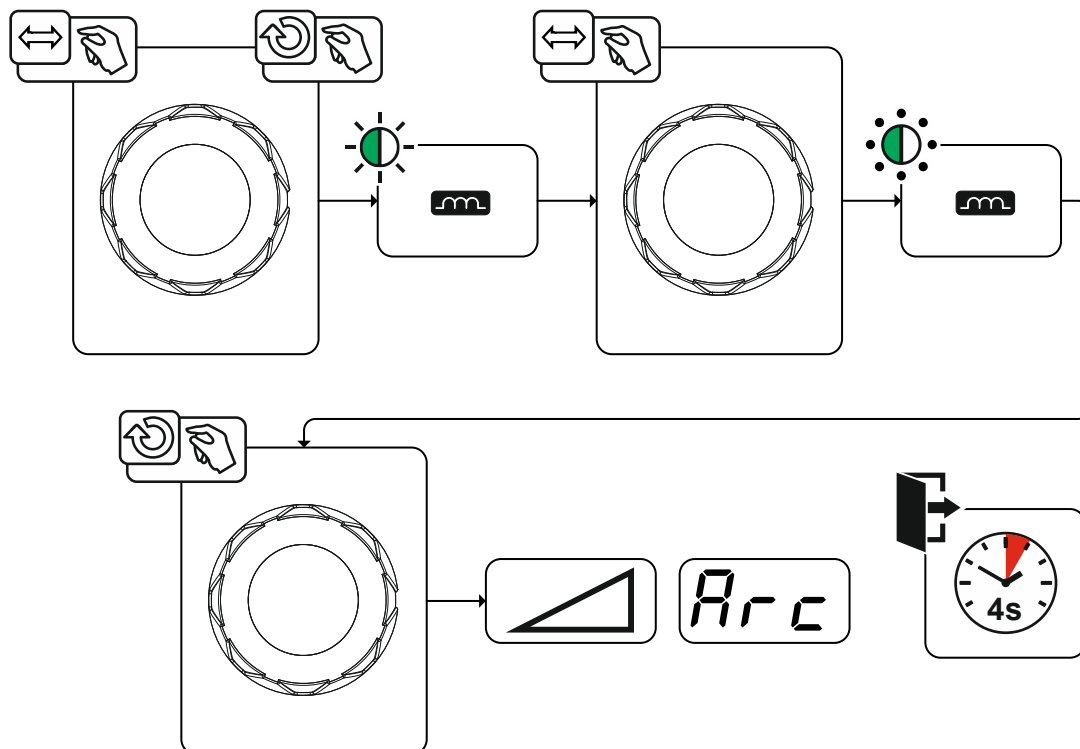
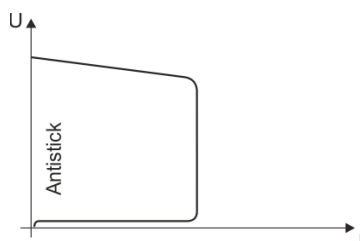

Figure 5-35

5.3.5 Antistick



The Antistick feature prevents the electrode from annealing.

Should the electrode stick despite the Arcforce feature, the machine automatically switches to the minimum current within approx. one second. This prevents the electrode from annealing. Check the welding current setting and correct for the welding task in hand.

Figure 5-36

5.3.6 Pulse welding

5.3.6.1 Average value pulse welding

A special feature with average value pulses is that the power source will always maintain the preset average value. This makes this method especially suitable for welding according to welding procedure specifications.

For average value pulsing (\overline{AUG}), switching takes place periodically between two currents whereby an average current value (\overline{i}), a pulse current (i_{PL}), pulse balance (b_{RL}) and pulse frequency (\overline{FrE}) must be specified. The set average current value in amperes is decisive. The pulse current is specified as a percentage of the average value current.

The pulse pause current (IPP) is not set. This value is calculated by the machine control to ensure that the average value of the welding current is maintained.

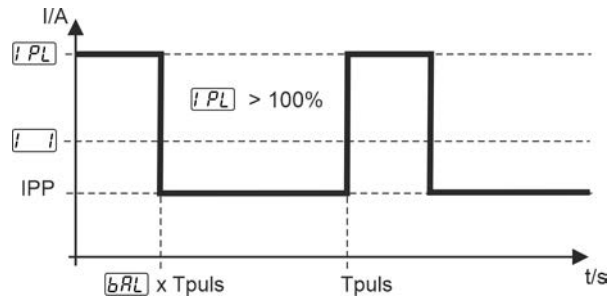

Figure 5-37

Setting the pulse current, pulse frequency and pulse balance

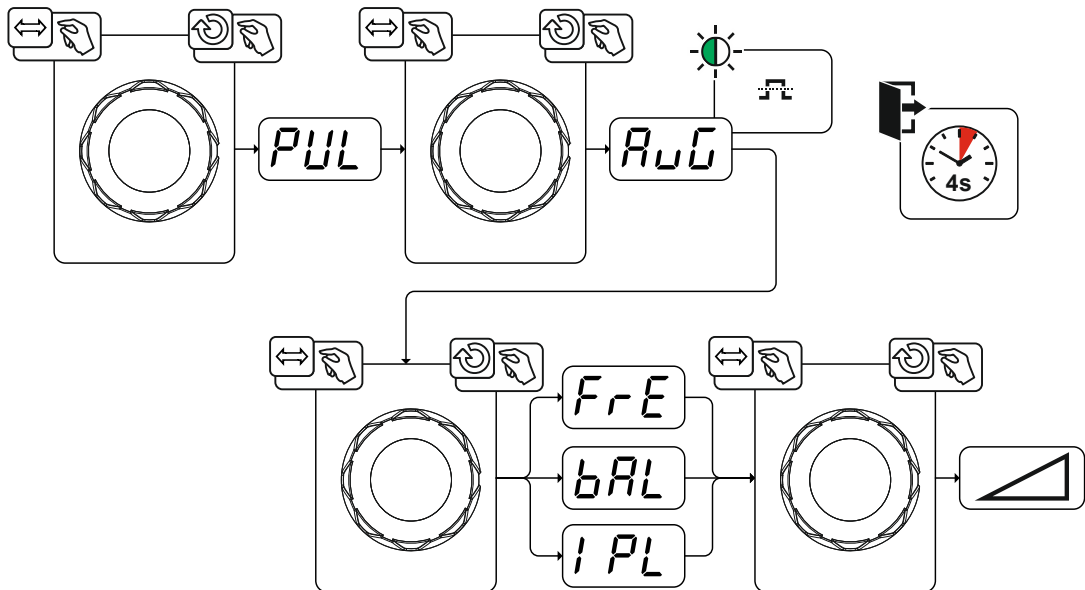

Figure 5-38

5.3.7 Arc length restriction (USP)

The function of arc length restriction **USP** stops the welding process when an excessive arc voltage is detected (an unusually large gap between electrode and workpiece). This function can be switched on or off in the Expert menu > see 5.3.8 chapter.

The arc length restriction cannot be used for cel characteristics (if available).

5.3.8 Expert menu (MMA)

The Expert menu has adjustable parameters stored that don't require regular setting. The number of parameters shown may be limited, e.g. if a function is deactivated.

The setting ranges for the parameter values are summarised in the Parameter overview section > see 10.1 chapter.

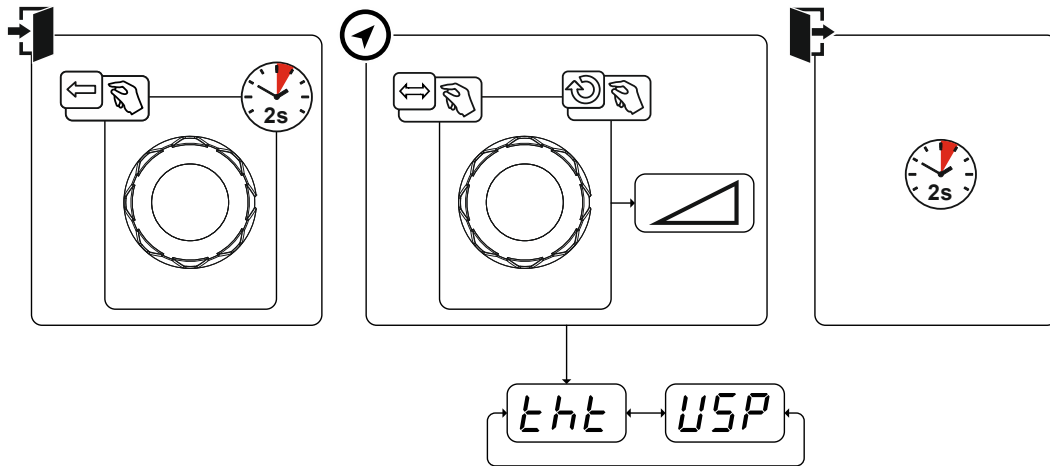

Figure 5-39

Display	Setting/selection
tHt	Hotstart time
USP	Arc length restriction > see 5.3.7 chapter <input type="checkbox"/> ON ----- Function switched on <input type="checkbox"/> OFF ----- Function switched off

5.4 Remote control

The remote controls are operated on the 19-pole remote control connection socket (analogue).

5.4.1 RTF-X TIG 19Pol



Functions

- Infinitely adjustable welding current (0% to 100%) depending on the main current preselected at the welding machine.
- Welding process start/stop (TIG)

5.4.2 RTF1 19POL

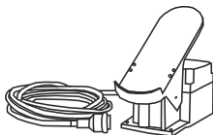

Functions

- Infinitely adjustable welding current (0% to 100%) depending on the preselected main current on the welding machine.
- Start/stop welding operation (TIG)

5.4.3 RT1 19POL



Functions

- Infinitely adjustable welding current (0% to 100%) depending on the preselected main current on the welding machine.

5.4.4 RTG1 19POL



Functions

- Infinite setting of the welding current (0% to 100%) depending on the main current preselected at the welding machine

5.4.5 RTA PWS2

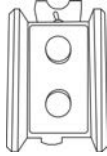

Functions

- Welding current setting (0 % to 100 %)
- Switch for changing the polarity. Only active in machines with pole reversing switch (PWS).
- Setting the Arcforce

5.5 Power-saving mode (Standby)

Using the parameter **[SbA]** in the machine configuration menu, the time for the power-saving mode can be set or the mode can be deactivated > see 5.7 chapter.

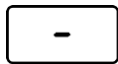

When power-saving mode is activated, the machine displays show the horizontal digit in the centre of the display only.

Actuating any operating element (e.g., turning a rotary knob) cancels the power-saving mode and the machine switches back to ready-to-weld mode.

5.6 Access control

The machine control can be locked to prevent unauthorised or accidental adjustments. The access lock has the following effect:

- The parameters and their settings in the machine configuration menu, expert menu and the function sequence can only be viewed but not changed.
- The welding procedure cannot be switched.

The parameters for setting the access block are configured in the machine configuration menu > see 5.7 chapter.

Enabling access block

- Assign the access code for the access block: Select parameter **[cod]** and select a number code (0–999).
- Enable access block: Set parameter **[loc]** to access block enabled **[on]**.

The access block activation is indicated by the "Access block active" signal light > see 4.2 chapter.

Disabling access block

- Enter the access code for the access block: Select parameter **[cod]** and enter the previously selected number code (0–999).
- Disable access block: Set parameter **[loc]** to access block disabled **[off]**. The only way to disable the access block is to enter the selected number code.

5.7 Machine configuration menu

Basic machine settings are defined in the machine configuration menu.

5.7.1 Selecting, changing and saving parameters

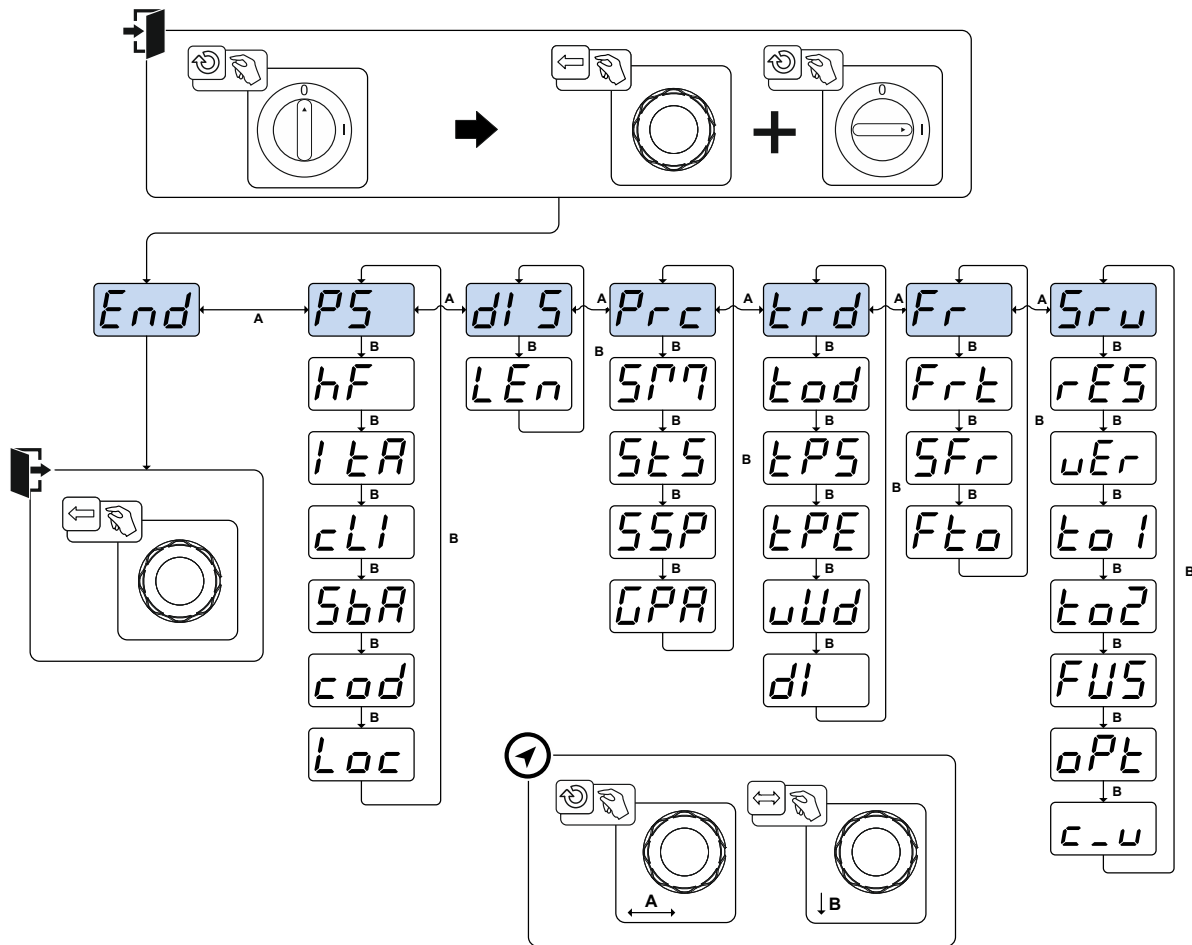
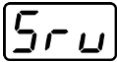
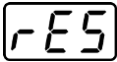
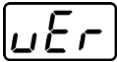
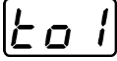
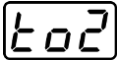
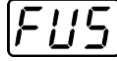
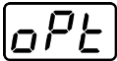
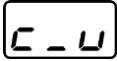

Figure 5-40

Display	Setting/selection
End	Exit the menu Exit
PS	Power source menu
HF	Ignition type (TIG) <input type="checkbox"/> on ----- HF start active (ex works) <input type="checkbox"/> FF ----- Lift arc ignition active
I tA	Re-ignition after arc interruption > see 5.2.4.3 chapter <input type="checkbox"/> FF ----- Function switched off or time setting
cLI	Minimum current limit (TIG) > see 5.2.3 chapter Depending on the set tungsten electrode diameter <input type="checkbox"/> FF ----- Function disabled <input type="checkbox"/> on ----- Function enabled (ex works)
SbA	Time-based power-saving mode > see 5.5 chapter Time to activation of the power-saving mode in case of inactivity. Setting <input type="checkbox"/> FF = disabled or numerical value 5-60 min..
cod	Access control – access code Setting: 000 to 999 (000 ex works)

Display	Setting/selection
Loc	Access control > see 5.6 chapter <input type="checkbox"/> on ----- Function enabled <input type="checkbox"/> off ----- Function disabled (ex works)
dis	Machine display menu
Len	Setting the system of measurement <input type="checkbox"/> mm ----- Length units in mm - metric system (factory setting). <input type="checkbox"/> in ----- Length units - imperial system.
PrC	Process menu
Spot	spotmatic operating mode > see 5.2.5.5 chapter Ignition by contact with the workpiece <input type="checkbox"/> on ----- Function enabled (ex works) <input type="checkbox"/> off ----- Function disabled
StS	Setting the spot time > see 5.2.5.5 chapter <input type="checkbox"/> on ----- Short spot time (factory setting) <input type="checkbox"/> off ----- Long spot time
SSP	Process activation setting > see 5.2.5.5 chapter <input type="checkbox"/> on ----- Separate process activation (ex works) <input type="checkbox"/> off ----- Permanent process activation
GPA	Automatic gas post-flow function > see 5.2.2.4 chapter <input type="checkbox"/> on ----- Function on <input type="checkbox"/> off ----- Function off (factory setting)
Trd	Torch configuration menu Set welding torch functions
Trd	Torch mode (ex works 1) > see 5.2.7.1 chapter
LPS	Alternative welding start – tap-start > see 5.2.5.3 chapter <input type="checkbox"/> on ----- Function enabled <input type="checkbox"/> off ----- Function disabled (factory setting)
LPE	Alternative welding end - Tap End > see 5.2.5.3 chapter <input type="checkbox"/> on ----- Function enabled. <input type="checkbox"/> off ----- Function disabled (factory setting).
UUD	Up/down speed > see 5.2.7.3 chapter Increase value > rapid current change Decrease value > slow current change
di	Current jump > see 5.2.7.4 chapter Current jump setting in ampere
Fr	Remote control menu
FrL	Responsiveness > see 5.2.8.1 chapter <input type="checkbox"/> Lin ----- Linear responsiveness <input type="checkbox"/> Log ----- Logarithmic responsiveness (factory setting)
SFr	Start program of foot-operated remote control > see 5.2.8.2 chapter <input type="checkbox"/> on ----- Function enabled (factory setting). <input type="checkbox"/> off ----- Function disabled.
Fto	Start / stop operation > see 5.2.8.3 chapter <input type="checkbox"/> on ----- Function enabled. <input type="checkbox"/> off ----- Function disabled (factory setting).

Display	Setting/selection
	Service menu Any changes to the service menu should be agreed with the authorised service personnel.
	Reset (resetting to factory settings) <input type="checkbox"/> OFF----- Switched off (factory setting) <input type="checkbox"/> CF0----- Reset all values and adjustments <input type="checkbox"/> t0----- Reset the operating time <input type="checkbox"/> t1----- Reset the arc time <input type="checkbox"/> t01----- Reset the operating time and arc time Reset by pressing the rotary encoder.
	Software version of the machine control Display of the software version (scrolling text).
	Operating time/arc time (resettable) <input type="checkbox"/> t01----- Display of the resettable operating time in hours and minutes (can be reset using the parameter RES). <input type="checkbox"/> t11----- Display of resettable arc time in hours and minutes (can be reset using the parameter RES)
	Operating time/arc time (total) <input type="checkbox"/> t02----- Display of the operating time in hours and minutes (total) <input type="checkbox"/> t12----- Display of the arc time in hours and minutes (total)
	Dynamic power adjustment > see 7.6 chapter
	Arc detection for welding helmets (TIG) Modulated waviness for better arc detection <input type="checkbox"/> 0----- Function disabled (factory setting) <input type="checkbox"/> 1----- Medium intensity <input type="checkbox"/> 2----- High intensity
	Calibration and validation mode > see 6.3 chapter <input type="checkbox"/> OFF----- Function disabled (factory setting) <input type="checkbox"/> ON----- Function enabled

6 Maintenance, care and disposal

6.1 General

DANGER



Risk of injury due to electrical voltage after switching off!

Working on an open machine can lead to fatal injuries!

Capacitors are loaded with electrical voltage during operation. Voltage remains present for up to four minutes after the mains plug is removed.

1. Switch off machine.
2. Remove the mains plug.
3. Wait for at last 4 minutes until the capacitors have discharged!

WARNING



Improper maintenance, testing and repairs!

Maintenance, testing and repair of the machine may only be carried out by skilled and qualified personnel (authorised service personnel). A competent person is someone who, based on training, knowledge and experience, can recognize the hazards and possible consequential damage that may occur when testing power sources and can take the necessary safety precautions.

- Follow the maintenance instructions > see 6.2 chapter.
- If any of the test requirements below are not met, the unit must not be put back into operation until it has been repaired and tested again.

Repair and maintenance work may only be performed by qualified authorised personnel; otherwise the right to claim under warranty is void. In all service matters, always consult the dealer who supplied the machine. Return deliveries of defective equipment subject to warranty may only be made through your dealer. When replacing parts, use only original spare parts. When ordering spare parts, please quote the machine type, serial number and item number of the machine, as well as the type designation and item number of the spare part.

Under the specified ambient conditions and normal working conditions this machine is essentially maintenance-free and requires just a minimum of care.

Contamination of the machine may impair service life and duty cycle. The cleaning intervals depend on the ambient conditions and the resulting contamination of the machine. The minimum interval is every six months.

6.1.1 Cleaning

- Clean the outer surfaces with a moist cloth (no aggressive cleaning agents).
- Purge the machine venting channel and cooling fins (if present) with oil- and water-free compressed air. Compressed air may overspeed and destroy the machine fans. Never direct the compressed air directly at the machine fans. Mechanically block the fans, if required.
- Check the coolant for contaminants and replace, if necessary.

6.1.2 Dirt filter

When using a dirt filter, the cooling air throughput is reduced and the duty cycle of the machine is reduced as a result. The duty cycle decreases with the increasing contamination of the filter. The dirt filter must be removed at regular intervals and cleaned by blowing out with compressed air (depending on the level of soiling).

6.2 Maintenance work, intervals

6.2.1 Daily maintenance tasks

Visual inspection

- Mains supply lead and its strain relief
- Gas cylinder securing elements
- Check hose package and power connections for exterior damage and replace or have repaired by specialist staff as necessary!
- Gas tubes and their switching equipment (solenoid valve)
- Check that all connections and wearing parts are hand-tight and tighten if necessary.
- Check correct mounting of the wire spool.
- Wheels and their securing elements
- Transport elements (strap, lifting lugs, handle)
- Other, general condition

Functional test

- Operating, message, safety and adjustment devices (Functional test)
- Welding current cables (check that they are fitted correctly and secured)
- Gas tubes and their switching equipment (solenoid valve)
- Gas cylinder securing elements
- Check correct mounting of the wire spool.
- Check that all screw and plug connections and replaceable parts are secured correctly, tighten if necessary.
- Remove any spatter.
- Clean the wire feed rollers on a regular basis (depending on the degree of soiling).

6.2.2 Monthly maintenance tasks

Visual inspection

- Casing damage (front, rear and side walls)
- Wheels and their securing elements
- Transport elements (strap, lifting lugs, handle)
- Check coolant tubes and their connections for impurities

Functional test

- Selector switches, command devices, emergency stop devices, voltage reducing devices, message and control lamps
- Check wire guide elements (wire feed roll holder, wire feed nipple, wire guide tube) for tight fit. Recommendation for replacing the wire feed roll holder (eFeed) after 2000 hours of operation, see replacement parts).
- Check coolant tubes and their connections for impurities
- Check and clean the welding torch. Deposits in the torch can cause short circuits and have a negative impact on the welding result, ultimately causing damage to the torch.

6.2.3 Annual test (inspection and testing during operation)

A periodic test according to IEC 60974-4 "Periodic inspection and test" has to be carried out. In addition to the regulations on testing given here, the relevant local laws and regulations must also be observed. For more information refer to the "Warranty registration" brochure supplied and our information regarding warranty, maintenance and testing at www.ewm-group.com!

6.3 Calibration and validation mode

In this mode, the inverter can be started and stopped and the current can be adjusted from minimum to maximum without being disturbed by welding process characteristics.

6.3.1 Machine control – Operating elements



Figure 6-1

Item	Symbol	Description
1		Display - left The current is shown as a nominal or actual value in the left machine display. Switching is done by pressing the rotary transducer.
2	I_1	Signal light for the actual value of the current The signal light flashes when the current is displayed as the actual value.
3	H	Signal light for inverter On/Off Lights up when the inverter is switched on.
4		Push-button for inverter On/Off Pressing this push-button turns on the inverter of the power source. Pressing it again switches the inverter off.
5	<i>spotArc spotmatic</i>	Signal light for the current flow Lights up when current is flowing.
6		Click wheel to set the current The welding current can be adjusted by turning. Press to switch the current display between nominal and actual value.
7		Display - right The voltage is shown as the actual value in the right machine display.

6.3.2 Activating the calibration and validation mode

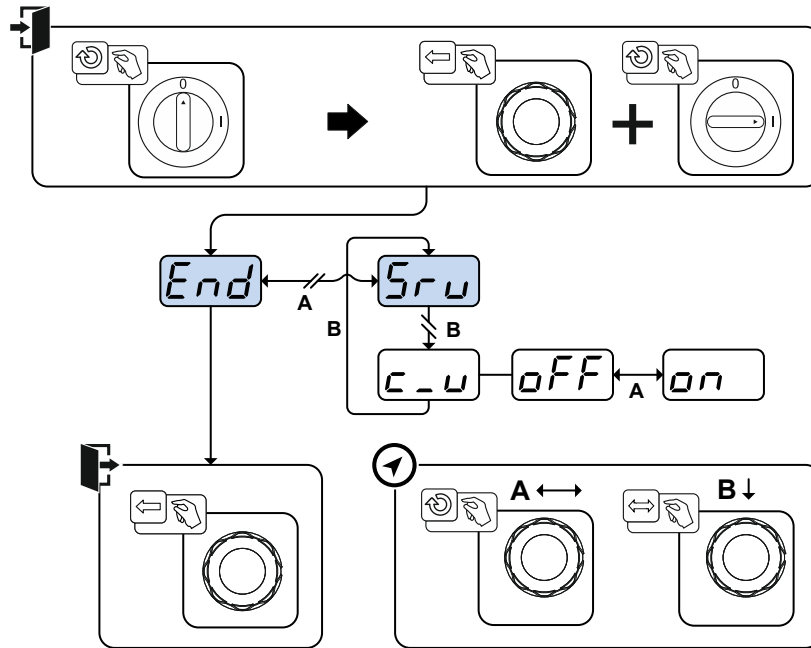

Figure 6-2

Display	Setting/selection
	Calibration and validation mode ----- Function disabled (factory setting) ----- Function enabled

6.3.3 Turning the inverter of the power source on and off

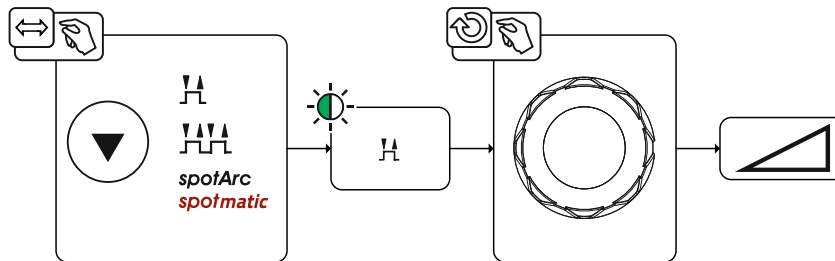

Figure 6-3

When the set mains fuse value is exceeded, the maximum output current is reduced and signalled by the flashing display . Please refer to the chapter “Dynamic power adjustment” > see 7.6 chapter.

6.3.4 Deactivating the calibration and validation mode

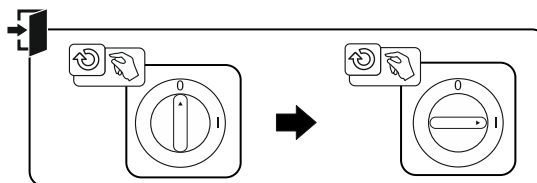

Figure 6-4

6.4 Disposing of equipment



Proper disposal!

The machine contains valuable raw materials, which should be recycled, and electronic components, which must be disposed of.

- Do not dispose of in household waste!
- Observe the local regulations regarding disposal!

In addition to the national or international regulations mentioned below, it is mandatory to follow the respective national laws and regulations on disposal.

- According to European provisions (Directive 2012/19/EU on Waste of Electrical and Electronic Equipment), used electric and electronic equipment may no longer be placed in unsorted municipal waste. It must be collected separately. The symbol depicting a waste container on wheels indicates that the equipment must be collected separately.

This machine has to be disposed of, or recycled, in accordance with the waste separation systems in use.

According to German law (law governing the distribution, taking back and environmentally correct disposal of electrical and electronic equipment (ElektroG)), used machines are to be placed in a collection system separate from unsorted municipal waste. The public waste management utilities (communities) have created collection points at which used equipment from private households can be disposed of free of charge.

The deletion of personal data is the responsibility of the end user.

Lamps, batteries or accumulators must be removed and disposed of separately before disposing of the device. The type of battery or accumulator and its composition is marked on the top (type CR2032 or SR44). The following EWM products may contain batteries or accumulators:

- Welding helmets
Batteries or accumulators are easy to remove from the LED cassette.
- Device controls
Batteries or accumulators are located on the back of these in corresponding sockets on the circuit board and are easy to remove. The controls can be removed using standard tools.

Information on returning used equipment or collections can be obtained from the respective municipal administration office. Devices can also be returned to EWM sales partners across Europe.

Further information on the topic of the disposal of electrical and electronic equipment can be found on our website at: <https://www.ewm-group.com/de/nachhaltigkeit.html>.

7 Rectifying faults

All products are subject to rigorous production checks and final checks. If, despite this, something fails to work at any time, please check the product using the following flowchart. If none of the fault rectification procedures described leads to the correct functioning of the product, please inform your authorised dealer.



7.1 Software version of the machine control

The query of the software versions only serves to inform the authorised service staff. It is available in the machine configuration menu > see 5.7 chapter.

7.2 Error messages (power source)

The possible error numbers displayed depend on the machine series and version!

Depending on the options of the machine display, a fault is shown as follows:

Display type - machine control	Display
Graphic display	
two 7-segment displays	
one 7-segment display	

The possible cause of the fault is signalled by a corresponding fault number (see table). In the case of an error, the power unit shuts down.

- Document machine errors and inform service staff as necessary.
- If multiple errors occur, these are displayed in succession.

Reset error (category legend)

^A The error message disappears when the error is eliminated.

^B The error message can be reset by pressing a push-button ◀.

All other error messages can only be reset by switching the machine off and on again.

Error 3: Tacho error

Categories A, B

- ✓ Fault in the wire feeder.
 - ✘ Check the electrical connections (connectors, lines).
- ✓ Permanent overload of the wire drive.
 - ✘ Do not lay the liner in tight radii.
 - ✘ Check the wire in the liner for ease of movement.

Error 4: Excess temperature

Category A

- ✓ The power source is overheating.
 - ✘ Allow the switched-on machine to cool.
- ✓ Fan is blocked, dirty or faulty.
 - ✘ Check the fan and clean or replace it.
- ✓ Air inlet or outlet is blocked.
 - ✘ Check the air inlet and outlet.

Error 5: Mains overvoltage

Category A ^[1]

- ✓ Mains voltage is too high.
 - ✘ Check the mains voltages and compare them with the connection voltages of the power source.

Error 6: Mains undervoltageCategory A ^[1]

- ✓ Mains voltage is too low.
 - ✘ Check the mains voltages and compare them with the connection voltages of the power source.

Error 7: Low coolant level

Category B

- ✓ Low flow rate.
 - ✘ Fill with coolant.
 - ✘ Check coolant flow - remove kinks in the hose package.
 - ✘ Adjust the flow threshold ^[2].
 - ✘ Clean the cooler.
- ✓ The pump does not turn.
 - ✘ Turn the pump shaft.
- ✓ Air in the coolant circuit.
 - ✘ Vent the coolant circuit.
- ✓ The hose package is not filled with coolant.
 - ✘ Switch the machine off and on > pump running > filling process.
- ✓ Operation with a gas-cooled welding torch.
 - ✘ Deactivate the torch cooling.
 - ✘ Connect the coolant feed and return with a hose bridge.

Error 8: Shielding gas error

Categories A, B

- ✓ No gas.
 - ✘ Check the gas supply.
- ✓ The pre-pressure is too low.
 - ✘ Remove kinks in the hose package (nominal value: 4-6 bar pre-pressure).

Error 9: Secondary overvoltage

- ✓ Overvoltage at the output: Inverter error.
 - ✘ Request service.

Error 10: Earth fault (PE error)

- ✓ Connection between welding wire and machine casing.
 - ✘ Remove the electrical connection.
- ✓ Connection between welding circuit and machine casing.
 - ✘ Check the connection and routing of the earth wire / welding torch.

Error 11: Fast shut-down

Categories A, B

- ✓ Remove the logical signal "Robot ready" during the process.
 - ✘ Eliminate errors in the higher-level control.

Error 16: Pilot arc power source - collective error

Category A

- ✓ The external emergency stop circuit has been interrupted.
 - ✘ Check the emergency stop circuit and eliminate the cause of the error.
- ✓ The emergency stop circuit of the power source has been activated (internally configurable).
 - ✘ Deactivate the emergency stop circuit.
- ✓ The power source is overheating.
 - ✘ Allow the switched-on machine to cool.
- ✓ Fan is blocked, dirty or faulty.
 - ✘ Check the fan and clean or replace it.
- ✓ Air inlet or outlet is blocked.
 - ✘ Check the air inlet and outlet.
- ✓ Short circuit on welding torch.
 - ✘ Check the welding torch.
 - ✘ Request service.

Error 17: Cold wire error

Category B

- ✓ Fault in the wire feeder.
 - ✘ Check the electrical connections (connectors, lines).
- ✓ Permanent overload of the wire drive.
 - ✘ Do not lay the liner in tight radii.
 - ✘ Check the liner for ease of movement.

Error 18: Plasma gas error

Category B

- ✓ No gas.
 - ✘ Check the gas supply.
- ✓ The pre-pressure is too low.
 - ✘ Remove kinks in the hose package (nominal value: 4-6 bar pre-pressure).

Error 19: Shielding gas error

Category B

- ✓ No gas.
 - ✘ Check the gas supply.
- ✓ The pre-pressure is too low.
 - ✘ Remove kinks in the hose package (nominal value: 4-6 bar pre-pressure).

Error 20: Low coolant level

Category B

- ✓ Low flow rate.
 - ✗ Fill with coolant.
 - ✗ Check coolant flow - remove kinks in the hose package.
 - ✗ Adjust the flow threshold ^[2].
 - ✗ Clean the cooler.
- ✓ The pump does not turn.
 - ✗ Turn the pump shaft.
- ✓ Air in the coolant circuit.
 - ✗ Vent the coolant circuit.
- ✓ The hose package is not filled with coolant.
 - ✗ Switch the machine off and on > pump running > filling process.
- ✓ Operation with a gas-cooled welding torch.
 - ✗ Deactivate the torch cooling.
 - ✗ Connect the coolant feed and return with a hose bridge.

Error 22: Excess coolant temperature

Category B

- ✓ Coolant is overheating ^[2].
 - ✗ Allow the switched-on machine to cool.
- ✓ Fan is blocked, dirty or faulty.
 - ✗ Check the fan and clean or replace it.
- ✓ Air inlet or outlet is blocked.
 - ✗ Check the air inlet and outlet.

Error 23: Excess temperature

Category A

- ✓ External component (e.g. HF ignition units) overheated.
- ✓ The power source is overheating.
 - ✗ Allow the switched-on machine to cool.
- ✓ Fan is blocked, dirty or faulty.
 - ✗ Check the fan and clean or replace it.
- ✓ Air inlet or outlet is blocked.
 - ✗ Check the air inlet and outlet.

Error 24: Pilot arc ignition error

Category B

- ✓ The pilot arc cannot ignite.
 - ✗ Check the welding torch equipment.

Error 25: Forming gas error

Category B

- ✓ No gas.
 - ✗ Check the gas supply.
- ✓ The pre-pressure is too low.
 - ✗ Remove kinks in the hose package (nominal value: 4-6 bar pre-pressure).

Error 26: Excess pilot arc module temperature

Category A

- ✓ The power source is overheating.
 - ✗ Allow the switched-on machine to cool.
- ✓ Fan is blocked, dirty or faulty.
 - ✗ Check the fan and clean or replace it.
- ✓ Air inlet or outlet is blocked.
 - ✗ Check the air inlet and outlet.

Error 32: Error I>0

- ✓ The current detection is incorrect.
 - ✗ Request service.

Error 33: Error UIST

- ✓ Voltage recording is faulty.
 - ✗ Eliminate the short circuit in the welding circuit.
 - ✗ Remove the external sensor voltage.
 - ✗ Request service.

Error 34: Electronics error

- ✓ A/D channel error
 - ✗ Switch the machine off and on.
 - ✗ Request service.

Error 35: Electronics error

- ✓ Slope error
 - ✗ Switch the machine off and on.
 - ✗ Request service.

Error 36: fault

- ✓  conditions violated.
 - ✗ Switch the machine off and on.
 - ✗ Request service.

Error 37: Excess temperature / electronics error

- ✓ The power source is overheating.
 - ✗ Allow the switched-on machine to cool.
- ✓ Fan is blocked, dirty or faulty.
 - ✗ Check the fan and clean or replace it.
- ✓ Air inlet or outlet is blocked.
 - ✗ Check the air inlet and outlet.

Error 38: Error IIST

- ✓ Short circuit in the welding circuit before welding.
 - ✗ Eliminate the short circuit in the welding circuit.
 - ✗ Request service.

Error 39: Electronics error

- ✓ Secondary overvoltage
 - ✗ Switch the machine off and on.
 - ✗ Request service.

Error 40: Electronics error

- ✓ Error I>0
- ✘ Request service.

Error 47: Radio link (BT)

Category B

- ✓ Connection error between the welding machine and peripheral unit.
- ✘ Note the documentation for the data interface with radio transmission.

Error 48: Ignition error

Category B

- ✓ No ignition at process start (automated machines).
- ✘ Check the wire feeding
- ✘ Check the load cable connections in the welding circuit.
- ✘ Clean corroded surfaces on the workpiece before welding if necessary.

Error 49: Arc interruption

Category B

- ✓ An arc interruption occurred during welding with an automated system.
- ✘ Check the wire feeding.
- ✘ Adjust the welding speed.

Error 50: Program number

Category B

- ✓ Internal error.
- ✘ Request service.

Error 51: Emergency stop

Category A

- ✓ The external emergency stop circuit has been interrupted.
- ✘ Check the emergency stop circuit and eliminate the cause of the error.
- ✓ The emergency stop circuit of the power source has been activated (internally configurable).
- ✘ Deactivate the emergency stop circuit.

Error 52: No wire feeder

- ✓ After switching on the automated system, no wire feeder (DV) was detected.
- ✘ Check or connect the control cables of the wire feeders.
- ✘ Check the identification number of the automated wire feeder (for 1DV: number 1, for 2DV: each a wire feeder with number 1 and a wire feeder with number 2).

Error 53: No wire feeder 2

Category B

- ✓ Wire feeder 2 was not detected.
- ✘ Check the control cable connections.

Error 54: VRD fault

- ✓ Error in the voltage reduction device.
- ✘ If necessary, disconnect the external machine from the welding circuit.
- ✘ Request service.

Error 55: Excess wire feeder current

Category B

- ✓ Excess current detected in the wire feed mechanism.
- ✘ Do not lay the liner in tight radii.
- ✘ Check the liner for ease of movement.

Error 56: Mains phase failure

- ✓ One phase of the mains voltage has failed.
- ✘ Check the mains connection, mains plug and mains fuses.

Error 57: Slave tachometer error

Category B

- ✓ Fault in the wire feeder (slave drive).
- ✘ Check the connections (connectors, lines).
- ✓ Permanent overload of the wire drive (slave drive).
- ✘ Do not lay the liner in tight radii.
- ✘ Check the liner for ease of movement.

Error 58: Short circuit

Category B

- ✓ Short circuit in the welding circuit.
- ✘ Eliminate the short circuit in the welding circuit.
- ✘ Place the welding torch on an insulated surface.

Error 59: Incompatible machine

- ✓ A machine connected to the system is not compatible.
- ✘ Disconnect the incompatible machine from the system.

Error 60: Incompatible software

- ✓ The software of a machine is not compatible.
- ✘ Disconnect the incompatible machine from the system
- ✘ Request service.

Error 61: Welding monitoring

- ✓ The actual value of a welding parameter is outside the specified tolerance range.
- ✘ Maintain the tolerance ranges.
- ✘ Adjust the welding parameters.

Error 62: System component

- ✓ The system component was not found.
- ✘ Request service.

Error 63: Mains voltage error

- ✓ Operating and mains voltage are incompatible.
- ✘ Check or adjust the operating and mains voltage.

^[1] only Picotig 220 pulse

^[2] See technical data for values and other switching thresholds > see 8 chapter.

7.3 Warnings

Depending on the display options of the machine display, a warning message is displayed as follows:

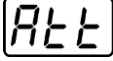
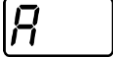
Display type - machine control	Display
Graphic display	
two 7-segment displays	
one 7-segment display	

The cause of the warning is indicated by a corresponding warning number (see table).

- In case of multiple warnings, these are displayed in sequence.
- Document machine warning and inform service personnel, if required.

Warning	Potential cause / remedy
1 Excess temperature	A shutdown is imminent due to excess temperature.
2 Half-wave failures	Check process parameters.
3 Welding torch cooling warning	Check the coolant level and top up if necessary.
4 Shielding gas	Check the shielding gas supply.
5 Coolant flow	Check min. flow rate. ^[2]
6 Wire reserve	Only a small amount of wire is left on the spool.
7 CAN bus failure	The wire feeder is not connected; the automatic circuit-breaker of the wire feed motor (reset the tripped automatic circuit breaker by actuating).
8 Welding circuit	The inductance of the welding circuit is too high for the selected welding task.
9 WF configuration	Check WF configuration.
10 Partial inverter	One of several partial inverters is not supplying welding current.
11 Excess temperature of the coolant ^[1]	Check temperature and switching thresholds. ^[2]
12 Welding monitoring	The actual value of a welding parameter is outside the specified tolerance range.
13 Contact error	The resistance in the welding circuit is too high. Check the earth connection.
14 Alignment error	Switch the machine off and on. If the error persists, notify Service.
15 Mains fuse	The power limit of the mains fuse is reached and the welding power is reduced. Check the fuse setting.
16 Shielding gas warning	Check the gas supply.
17 Plasma gas warning	Check the gas supply.
18 Forming gas warning	Check the gas supply.
19 Gas warning 4	reserved
20 Coolant temperature warning	Check the coolant level and top up if necessary.
21 Excess temperature 2	reserved
22 Excess temperature 3	reserved
23 Excess temperature 4	reserved

Warning	Potential cause / remedy
24 Coolant flow warning	Check the coolant supply. Check the coolant level and top up if necessary. Check flow and switching thresholds. ^[2]
25 Flow 2	reserved
26 Flow 3	reserved
27 Flow 4	reserved
28 Wire stock warning	Check the wire feeding.
29 Low wire 2	reserved
30 Low wire 3	reserved
31 Low wire 4	reserved
32 Tacho error	Fault of the wire feeder - permanent overload of the wire drive.
33 Wire feed motor excess current	Excess current detected on wire feed motor.
34 JOB unknown	JOB selection was not carried out because the JOB number is unknown.
35 Wire feed motor slave excess current	Excess current detected on wire feed motor slave (push/push system or intermediate drive).
36 Slave tacho error	Fault of the wire feeder - permanent overload of the wire drive (push/push system or intermediate drive).
37 FAST bus failure	The wire feeder is not connected (reset by actuating the automatic circuit breaker of the wire feed motor).
38 Incomplete component information	Check the Xnet component management.
39 Halfwave failure	Check supply voltage.
40 Weak power grid	Check supply voltage.
41 Cooling unit not recognised	A liquid-cooled welding torch was connected but no cooling unit has been detected. <ul style="list-style-type: none"> • Check the connection of the cooling unit • Use a gas-cooled welding torch
47 Battery (remote control, type BT)	Battery level is low (replace battery)

^[1] only for the XQ machine series

^[2] See technical data for values and other switching thresholds > see 8 chapter.

7.4 Checklist for rectifying faults

The correct machine equipment for the material and process gas in use is a fundamental requirement for perfect operation!

Legend	Symbol	Description
	↗	Fault/Cause
	✘	Remedy

Mains fuse triggers

↗ Mains fuse triggers - unsuitable mains fuse

✘ Set up recommended mains fuse > see 8 chapter.

Functional errors

- ✓ Several parameters cannot be set (machines with access block)
 - ✗ Entry level is blocked, disable access lock > see 5.6 chapter
- ✓ All machine control signal lights are illuminated after switching on
- ✓ No machine control signal light is illuminated after switching on
- ✓ No welding power
 - ✗ Phase failure > check mains connection (fuses)
- ✓ Connection problems
 - ✗ Make control lead connections and check that they are fitted correctly.
- ✓ Loose welding current connections
 - ✗ Tighten power connections on the torch and/or on the workpiece
 - ✗ Tighten contact tip correctly

No arc ignition

- ✓ Incorrect ignition type setting.
 - ✗ Ignition type: Select "HF start". Depending on the machine, the setting is defined by the change-over switch for ignition types or the hF parameter in one of the machine menus (see the "Control operating instructions", if applicable).

Bad arc ignition

- ✓ Material inclusions in the tungsten electrode due to contact with filler material or workpiece
 - ✗ Regrind or replace the tungsten electrode
- ✓ Bad current transfer on ignition
 - ✗ Check the setting on the "Tungsten electrode diameter/ignition optimisation" rotary dial and increase if necessary (higher ignition energy).

Welding torch overheated

- ✓ Loose welding current connections
 - ✗ Tighten power connections on the torch and/or on the workpiece
 - ✗ Tighten contact tip correctly
- ✓ Overload
 - ✗ Check and correct welding current setting
 - ✗ Use a more powerful welding torch

Unstable arc

- ✓ Material inclusions in the tungsten electrode due to contact with filler material or workpiece
 - ✗ Regrind or replace the tungsten electrode
- ✓ Incompatible parameter settings
 - ✗ Check settings and correct if necessary

Pore formation

- ✓ Inadequate or missing gas shielding
 - ✗ Check shielding gas setting and replace shielding gas cylinder if necessary
 - ✗ Shield welding site with protective screens (draughts affect the welding result)
 - ✗ Use gas lens for aluminium applications and high-alloy steels
- ✓ Unsuitable or worn welding torch equipment
 - ✗ Check size of gas nozzle and replace if necessary
- ✓ Condensation in the gas tube
 - ✗ Purge hose package with gas or replace

7.5 Voltage reducing device

The voltage reduction device (VRD) is used to increase safety, especially in dangerous environments (such as shipbuilding, pipeline construction, mining).

The use of a voltage reduction device is mandatory in some countries and specified in many in-house safety regulations for welding power sources.

The VRD > see 4.2 chapter signal light lights up when the voltage reducing device is working properly and the output voltage has been reduced to the values specified in the relevant standard (technical data > see 8 chapter).

7.6 Dynamic power adjustment

This requires use of the appropriate mains fuse.

Observe mains fuse specification > see 8 chapter!

This function enables aligning the machine to the mains connection fusing to avoid continuous tripping of the mains fuse. The maximum power input of the machine is limited by an exemplary value for the existing mains fuse (several levels available).

You can predefine this value in the machine configuration menu > see 5.7 chapter using parameter `[FUS]`.

The selected value will be shown on the machine display `[ERL]` for two seconds after the machine has been switched on.

The function automatically adjusts the welding power to an uncritical level for the mains fuse.



When using a 20-A mains fuse, a suitable mains plug has to be installed by a qualified electrician.

7.7 Resetting welding parameters to the factory settings

All customised welding parameters that are stored will be replaced by the factory settings.





To reset the welding parameters or machine settings to the factory settings, select parameter `[E5]` in the service menu `[SRV]` > see 5.7 chapter.

8 Technical data

Performance specifications and guarantee only in connection with original spare and replacement parts!

8.1 Picotig 220 puls DC 5P

8.1.1 Mains voltage 230 V

	TIG	MMA
Welding current (I ₂)	5 A to 220 A	5 A to 190 A
Welding voltage according to standard (U ₂)	10,2 V to 18,8 V	20,2 V to 27,6 V
Duty cycle DC at 40° C ^[1]	220 A (40 %) 190 A (60 %) 160 A (100 %)	190 A (35 %) 155 A (60 %) 125 A (100 %)
Open circuit voltage (U ₀)	97 V	
Mains voltage (Tolerance)	1 x 230 V (-40 % to +15 %)	
Frequency	50/60 Hz	
mains fuse ^[2]	1 x 16 A	
Mains connection cable	H07RN-F3G2,5	
max. Connected load (S ₁)	4,9 kVA	6,2 kVA
Rec. Generator rating	6,6 kVA	8,4 kVA
Power consumption P _i ^[3]	10 W	
Cos φ / efficiency	0,99 / 84 %	
Protection class	I	
Overvoltage category	III	
Contamination level	3	
Insulation class / protection classification	H / IP 23	
Residual current circuit breaker	Type B (recommended)	
Noise level ^[4]	<70 dB(A)	
Ambient temperature	-25 °C to +40 °C	
Machine cooling	Fan (AF)	
Torch cooling	gas	
Workpiece lead (min.)	35 mm ²	
EMC class	A	
Test mark	 /  /  / 	
Standards used	See declaration of conformity (appliance documents)	
Dimensions (l x b x h)	454 x 165 x 321 mm 17.9 x 6.5 x 12.6 inch	
Weight	10 kg 22 lb	

^[1] Load cycle: 10 min. (60 % DC \triangleq 6 min. welding, 4 min. pause)

^[2] Safety fuses are recommended DIAZED xxA gG. When using automatic cutouts, the "C" trigger characteristic must be used.





^[3] Power in idle state without external or internal peripherals.

^[4] Noise level during idle mode and operation under standard load according to IEC 60974-1 at the maximum operating point.

8.1.2 Mains voltage 120 V

The performance specifications refer to machines with several mains voltage variants (multivolt capability). Please note the information on the relevant rating plate.

 **The increased current consumption at a lower mains voltage requires the installation of a suitable mains plug > see 5.1.7 chapter.**

	TIG	MMA
Welding current (I ₂)	5 A to 170 A	5 A to 120 A
Welding voltage according to standard (U ₂)	10,2 V to 16,8 V	20,2 V to 24,8 V
Duty cycle DC at 40° C ^[1]	170 A (40 %) 150 A (60 %) 120 A (100 %)	120 A (40 %) 100 A (60 %) 85 A (100 %)
Open circuit voltage (U ₀)	97 V	
Mains voltage (Tolerance)	1 x 120 V (-15 % to +15 %)	
Frequency	50/60 Hz	
mains fuse ^[2]	1 x 20 A	
Mains connection cable	H07RN-F3G2,5	
max. Connected load (S ₁)	3,4 kVA	3,5 kVA
Rec. Generator rating	4,6 kVA	4,7 kVA
Power consumption P _i ^[3]	10 W	
Cos φ / efficiency	0,99 / 84 %	
Protection class	I	
Overvoltage category	III	
Contamination level	3	
Insulation class / protection classification	H / IP 23	
Residual current circuit breaker	Type B (recommended)	
Noise level ^[4]	<70 dB(A)	
Ambient temperature	-25 °C to +40 °C	
Machine cooling	Fan (AF)	
Torch cooling	gas	
Workpiece lead (min.)	35 mm ²	
EMC class	A	
Test mark	 /  /  / 	
Standards used	See declaration of conformity (appliance documents)	
Dimensions (l x b x h)	454 x 165 x 321 mm 17.9 x 6.5 x 12.6 inch	
Weight	10 kg 22 lb	

^[1] Load cycle: 10 min. (60 % DC \triangleq 6 min. welding, 4 min. pause)

^[2] Safety fuses are recommended DIAZED xxA gG. When using automatic cutouts, the "C" trigger characteristic must be used.

^[3] Power in idle state without external or internal peripherals.

^[4] Noise level during idle mode and operation under standard load according to IEC 60974-1 at the maximum operating point.

9 Accessories

Performance-dependent accessories like torches, workpiece leads, electrode holders or intermediate hose packages are available from your authorised dealer.

9.1 Shielding gas supply (shielding gas cylinder for welding machine)

Type	Designation	Item no.
Proreg Ar/CO2 230bar 15l D	Pressure regulator with manometer	394-008488-10015
Proreg Ar/CO2 230bar 30l D	Pressure regulator with manometer	394-008488-10030
DM 842 Ar/CO2 230bar 15l D	Pressure regulator with manometer	394-002910-00015
GH 2X1/4" 2M	Gas hose	094-000010-00001
GH 2x1/4" 3m	Gas hose	094-000010-00003
GH 2X1/4" 5m	Gas hose	094-000010-00005
GH 2X1/4" 10 m	Gas hose	094-000010-00011
GH 2X1/4" 15m	Gas hose	094-000010-00015

9.2 Transport system

Type	Designation	Item no.
Trolly 35-1	Transport vehicle	090-008629-00000

9.3 19-pole remote control

Type	Designation	Item no.
RT1 19POL	Remote control current	090-008097-00000
RTG1 19POL 5m	Remote control, current	090-008106-00000
RTG1 19POL 10m	Remote control, current	090-008106-00010
RTF1 19POL 5 M	Foot-operated remote control current with connection cable	094-006680-00000
RTF-X TIG 19pol 5 m	Foot-operated remote control, current, with connection cable	090-008855-00005
RTA PWS2	Remote control, welding current setting (0 % to 100 %), pole reversing switch, setting Arcforce	090-008856-00000

9.3.1 Connection cables

Type	Designation	Item no.
RA5 19POL 5M	Remote control e.g. connection cable	092-001470-00005
RA10 19POL 10m	Remote control e.g. connection cable	092-001470-00010
RA20 19POL 20m	Remote control e.g. connection cable	092-001470-00020

9.4 Option for retrofitting

Type	Designation	Item no.
ON Filter TG.12	Dirt filter for the air inlet	092-004516-00000
ON TG	Carrying strap	092-004310-00000
ON AL D13/27	Cap for load sockets	092-003282-00000

9.5 General accessories

Type	Designation	Item no.
SKGS 16A 250V CEE7/7, DIN 49440/441	Protective contact plug, solid rubber	094-001756-00000
ADAP CEE16/SCHUKO	Earth contact coupling/CEE16A plug	092-000812-00000
KLF-L1-N-PE-NETZ	Mains-cable label	094-014869-00001

10 Appendix

10.1 Parameter overview – setting ranges

10.1.1 TIG welding

Welding data display	Parameter / function	Setting range				
		Standard (factory set)	Min.		Max.	Unit
	Gas pre-flow time	0,5	0	-	20	s
	Start current	50	1	-	200	%
	Start time	0	0		20	s
	Up-slope time	1	0	-	20	s
	Main current	100	5	-	220	A
	Slope time (main current to secondary current)	0	0	-	20	s
	Secondary current	50	1	-	200	%
	Slope time (secondary current to main current)	0	0		20	s
	Down-slope time	1	0	-	20	s
	End current	20	1	-	200	%
	End current time	0	0	-	20	s
	Gas post-flow time	8	0	-	20	s
	Diameter of the tungsten electrode	2,4	1,0		3,2	mm
	Torch mode	1	1	-	4	-
	Up/down speed	10	1	-	100	-
	Current jump	10	1	-	20	A
	Pulse welding (/	off	off	-	AUt	-
	Pulse frequency - (average value pulsing)	2,0	0,2	-	2000	Hz
	Pulse balance - (average value pulsing)	50	1	-	99	%
	Pulse current - (average value pulsing)	140	1	-	200	%
	Automated pulsing ()	-	-	-	-	-
	Slope times (spotArc/spotmatic)	off	off	-	on	-
	Re-ignite after arc interruption	5,0	off	-	5,0	s
	Spot time - spotArc®	2,0	0,1	-	20,0	s
	Spot time - spotmatic - (>)	2,0	0,1	-	20,0	s
	Spot time - spotmatic - (>)	200	5	-	995	ms

10.1.2 MMA welding

Welding data display	Parameter / function	Setting range				
		Standard (factory set)	Min.		Max.	Unit
	Hot start current	120	1	-	200	%
	Hot start time	0,5	0,1	-	20,0	s
	Main current	100	5	-	190	A
	Pulse welding ()	off	off	-	AvG	-
	Pulse frequency	1,2	0,2	-	500	Hz
	Pulse balance	30	1	-	99	%
	Pulse current	142	1	-	200	%
	Arcforce correction	0	-10	-	10	-

10.1.3 Basic parameters (independent of process)

Welding data display	Parameter / function	Setting range				
		Standard (factory setting)	Min.		Max.	Unit
	Ignition mode switching	on	off	-	on	-
	Time-based energy-saving function	20	off	-	60	min
	Remote control response	LoG	LIn	-	LoG	
	Start program of the remote control	on	off	-	on	
	Dynamic power adjustment (230V)	16	10	-	20	A
	Dynamic power adjustment (120V)	20	10	-	20	A
	Arc detection for welding helmets (TIG)	0	0	-	2	-
	Calibration and validation mode	off	off	-	on	

10.2 Average shielding gas usage

	Gas nozzle number	4	5	6	7	8	10
	∅ mm	6.5	8.0	9.5	11	12.5	16
	∅ inch	0.26	0.31	0.37	0.43	0.5	0.63
l/min		6	8	10	12		15
gal/min		1.58	2.11	2.64	3.17		3.96

10.3 Searching for a dealer

Sales & service partners
www.ewm-group.com/en/specialist-dealers



"More than 400 EWM sales partners worldwide"